

SAFE *CLEANBOX*

USER AND MAINTENANCE MANUAL

STK 110

MODEL: STK 110

SERIAL N.: BM_____



DISCLAIMER

This document is the exclusive property of BICARjet S.r.l., all rights are reserved. Any disclosure, copying or transfer of the content to third parties is prohibited without the prior authorization of the Company.

BICARjet S.r.l. does not accept any liability for injury to persons or damage to property resulting from the misuse of this product or from failure to follow the directions, warnings, instructions and precautions reported in this user manual.

This user manual is provided in hardcopy format only and should always accompany the SAFE CleanBox device.

SAFE CleanBox is manufactured by:

BICARjet S.r.l.
Registered office - Via Nona Strada, 2 - 35129 Padova, Italy
VAT NUMBER: 03735720280

CONTENTS

DISCLAIMER	2
1 GENERAL INFORMATION.....	6
1.1 INTENDED USE	6
1.2 CLASSIFICATION	6
1.3 SYMBOLS.....	7
1.4 PRELIMINARY WARNINGS	7
1.5 GENERAL SAFETY RECOMMENDATIONS:	7
1.6 RECOMMENDATIONS REGARDING LIGHTING AND VENTILATION OF THE PREMISES	9
1.7 CONNECTIONS	10
1.7.1 <i>Electrical connection</i>	10
1.7.2 <i>Compressed air connection</i>	10
1.7.3 <i>Water connection</i>	10
1.7.4 <i>Drain connection</i>	10
1.8 SAFETY DEVICES	10
1.9 COMPOSITION OF THE DEVICE	15
2 INSTALLATION.....	22
2.1 LIFTING AND TRANSPORT.....	23
2.2 SET-UP OF USE ENVIRONMENT	24
2.3 PREPARATION FOR INSTALLATION.....	26
2.3.1 <i>Preparation of the electrical system</i>	26
2.3.2 <i>Preparation of the compressed air system</i>	26
2.3.3 <i>Preparation of the water system</i>	26
2.3.4 <i>Preparation of the drainage system</i>	26
2.3.5 <i>Preparation of the work area</i>	27
2.4 POST-INSTALLATION CHECKS	27
3 METHOD OF USE	29
3.1 SWITCHING ON THE DEVICE.....	29
3.2 START-UP, OPERATION - LOGIN.....	29
3.2.1 <i>CREATION OF NEW OPERATOR</i>	31
3.2.2 <i>OPERATION OF THE DEVICE:</i>	32
3.2.3 <i>OPERATION of the conveyor belt</i>	33
3.2.4 <i>START CLEANING OF THE INSTRUMENTS</i>	35
3.2.5 <i>INSTRUMENT TREATMENT PROCEDURE</i>	36
3.2.6 <i>INSTRUMENT RINSING PROCEDURE</i>	36
3.2.7 <i>INSTRUMENT BLOWING PROCEDURE</i>	37
3.2.8 <i>CABIN SANITIZATION PROCEDURE</i>	38
3.2.9 <i>MATERIALS COMPATIBLE WITH THE TREATMENT</i>	42
3.3 SWITCHING OFF	43

3.4	NOTIFICATIONS / ALARMS	45
3.4.1	ALARM GUIDE.....	47
3.5	REPLACEMENT OF CONSUMABLES	50
4	MAINTENANCE.....	52
4.1	ROUTINE MAINTENANCE	52
4.2	PREVENTIVE MAINTENANCE	62
4.3	NON-ROUTINE MAINTENANCE AND REPAIRS	64
4.4	POST-MAINTENANCE CHECKS	65
4.5	TECHNICAL ASSISTANCE.....	66
4.6	WARRANTY TERMS AND CONDITIONS.....	66
5	CLEANING.....	67
6	DISPOSAL	67
7	TECHNICAL FEATURES	68
8	LABELLING.....	69
8.1	RATING PLATE INFORMATION	69
8.2	INTERNAL MARKINGS.....	69
8.3	WATER SUPPLY, COMPRESSED AIR AND DRAINAGE	70
8.4	WARNING MARKINGS	70
8.5	SAFETY SYMBOLS AND LABELLING	70
9	ELECTROMAGNETIC COMPATIBILITY.....	73
9.1	EMC WARNINGS.....	73
10	TUTORIAL ON CORRECT CLEANING OF THE INSTRUMENTS	74
10.1	DRILL TUTORIAL	74
10.2	SHIELDED CABLE - 296-4 05168	75
10.3	SHIRT FOR LAPAROSCOPIC (CANNULATED) INSTRUMENTS	75
10.4	PROCEDURE FOR CANNULATED INSTRUMENTS	76
10.5	MONOPOLAR INSULATED FORCEPS	78
10.6	VICKERS ELEVATOR - KLS MARTIN 23-506-17	78
10.7	BONE FORCEPS - SYNTHES 398.81.....	79
10.8	BIPOLAR FORCEPS - SOFAR 82410001 / BISSINGER 82410034.....	80
10.9	TEMPORARY COVER - STORZ 27 026 UO	82
10.10	MONOPOLAR HOOK FOR COAGULATION	83
10.11	BIPOLAR FORCEPS - MICRO FRANCE CEV 136.....	84
10.12	MONOPOLAR FORCEPS - REMA 28 - 247 - 000	86
10.13	CYSTOSCOPY SHIRT - STORZ 27 026 B.....	87
10.14	OBJECT ENTIRELY IN METAL. TREAT WITH THE JET IN FULL.....	87
10.15	OBJECT X - MITEK 214615.....	89
10.16	ARTHROSCOPY FORCEPS - MITEK 214602	90
10.17	KARL STORZ TROCAR 30 160 H2 (CANNULA WITH STOPCOCK)	92
10.18	EYE MICROSURGERY KIT - STEEL	94

10.19	KARL STORZ ROD-LENS SYSTEM 27005AA	95
11	SW MANUAL - HMI PANEL.....	96
11.1	MACHINE READY - HOME SCREEN	96
11.2	SETTINGS/MENU SCREEN	96
11.3	SISTEMA (SYSTEM) SCREEN.....	97
11.4	DIAGNOSTICA (DIAGNOSTICS) SCREENS	97
11.5	PARAMETRI (PARAMETERS) SCREEN	99
11.6	PARAMETRI DI FUNZIONAMENTO (OPERATING PARAMETERS) SETTING SCREENS	100
11.7	CICLO PROVA (TEST CYCLE) SCREENS.....	101
11.8	CONTATORI (COUNTERS) SCREEN.....	102
11.9	REGISTRO ALLARMI (ALARMS REGISTER) SCREEN	102
11.10	SANIFICAZIONI (SANITIZATION) LOG SCREEN	103
11.11	OPERAZIONI (OPERATION) LOG SCREEN.....	103
11.12	ESPORTAZIONE DATI (DATA EXPORT) MENU SCREEN	103
11.13	PORTE APERTE CABINA (CABIN OPEN DOORS) SCREEN.....	104
11.14	MACCHINA IN STAND-BY (MACHINE IN STAND-BY) SCREEN	104
11.15	LAVAGGIO ATTIVO (ACTIVE WASHING) SCREEN.....	104
11.16	RISCIACQUO ATTIVO (ACTIVE RINSING) SCREEN	105
11.17	CICLO DI SANIFICAZIONE (SANITIZATION CYCLE) SCREEN	105
	11.17.1 <i>First phase: rinsing the cabin with water only.....</i>	106
	11.17.2 <i>Second phase: rinsing of the cabin with water and sanitizer</i>	106
	11.17.3 <i>Waiting time before final rinse with water</i>	107
	11.17.4 <i>Third phase: final rinse with water only.....</i>	108
11.18	REMINDER TO CARRY OUT SANITIZATION	108
11.19	CICLO GONFIAGGIO GUANTI (GLOVE INFLATION CYCLE) SCREEN	109
11.20	MACCHINA IN EMERGENZA (MACHINE IN EMERGENCY MODE) SCREEN	109

1 GENERAL INFORMATION

SAFE CleanBox is a medical device intended for sterilization centres/laboratories for the pre-treatment of RMDs (Reusable Medical Devices) and is used for pre-washing RMDs prior to washing, disinfection and sterilization processes.

The process is similar in outcome to highly effective and efficient mechanical brushing, and involves the use of a jet of compressed air and granular sodium bicarbonate to remove residues from the surfaces of the RMDs without causing structural damage. The sodium bicarbonate used (SAFEKLINIC brand) is totally soluble and is not classified as dangerous for the environment or for the operator.

The system consists of a cabin similar in design to a "glove box" equipped with gloves to manipulate the instruments without these coming into direct contact with the operator's hands, and the operations are confined in a closed environment for the benefit of the operator's safety and comfort.

Inside the cabin are two handpieces, one for bicarbonate treatment with compressed air and water and the other for rinsing with compressed air and water. The push-button panel, located inside the cabin, makes the work easier by allowing the operator to use the main controls, such as opening the doors to move the baskets in and out of the cabin, without having to leave the station or removing their hands from the gloves. The flanges on the front part of the cabin have been ergonomically designed for operator comfort and ease of use. They allow a wide range of action and a quick release system allows them to be removed easily in order to change the gloves in the event of a fault. The two handpieces are operated via a two pedal control that allows each handpiece to be operated independently. The cabin can be equipped with a motorized system for automatically loading and unloading the DIN baskets in which the instruments to be cleaned are placed.

THE EFFECTIVENESS OF REMOVAL OF RESIDUES/CONTAMINANTS FROM RMDs IS GUARANTEED ONLY AND EXCLUSIVELY THROUGH THE USE OF SODIUM BICARBONATE, ACCORDING TO THE INSTRUCTIONS GIVEN IN CHAPTER 3.2.4.

1.1 INTENDED USE

The intended use is the preparation of the RMD for the washing process in the instrument washer. The action is carried out by bringing a jet of compressed air and bicarbonate in contact with the object to be treated, in order to remove any contaminant from the surface without damaging it and increase the effectiveness of the subsequent phases. This operation is conceptually similar to manual brushing of the RMDs, normally carried out prior to washing, disinfection and/or sterilization processes.

1.2 CLASSIFICATION

Classification according to Regulation (EU) 2017/745 Annex VIII rule 13 class I.



CAUTION!

THE DEVICE IS INTENDED TO BE USED BY SPECIALLY TRAINED OPERATORS IN STERILIZATION CENTRES WITHIN OR OUTSIDE HOSPITALS, AND IN LABORATORIES WHERE RMDs ARE RECONDITIONED.

1.3 SYMBOLS



In order to make the reading of this manual simple and clear, the symbols used as important warnings for the correct and safe use of the device are shown below.



Requirement for correct use

This symbol precedes information for the correct use of the device.



Information requirement

This symbol precedes useful and general information, which guides the user in the informed use of the device and/or the performance of actions.



It indicates that the product has been designed and manufactured in compliance with the safety requirements of Regulation (EU) 2017/745 (Medical device class I and in compliance with classification rule 13 as indicated in Annex VIII).

1.4 PRELIMINARY WARNINGS

Failure to observe the following warnings and the rules and precautions described in this user manual will immediately void any warranty on the SAFE CleanBox device.

BICARjet S.r.l. is not liable for any injury to persons or damage to property resulting from failure to comply with the rules or precautions listed below and set out in general in this user manual.

The instructions or warnings are not intended to replace the accident prevention safety regulations, but to supplement them and encourage compliance with them.

The employer must train the personnel in the risks of accidents, in the use of personal protective equipment, in the risks of noise emissions and in the general accident prevention regulations provided for by international directives and by the legislation of the country of destination of the machinery. The operating, maintenance, cleaning and control personnel, etc. must therefore strictly comply with the accident prevention regulations of the country of destination of the machinery.

This use and maintenance manual applies to the STK 110 model.

1.5 GENERAL SAFETY RECOMMENDATIONS:

BICARjet® S.r.l. has made every effort to design the **SAFE CleanBox** machine and to make it as **INTRINSICALLY SAFE** as possible.

The manufacturer has also equipped the machine with all the protective and safety devices considered necessary. Finally, it has provided enough information for it to be used safely and correctly.

In each chapter, the following information is provided for all human-machine interaction whenever necessary:

- The operator's minimum qualification required;
- The number of operators needed;
- The status of the system;
- The residual risks;
- The Personal Protective Equipment required or recommended;

- The prevention of human error;
- The prohibitions/obligations regarding reasonably foreseeable non-intended use/behaviour.

The user can integrate the information provided by the manufacturer with additional instructions to increase safety in using the system. Clearly this should not include information that contradicts information given in this instruction manual.

For instance, it is important to pay attention to the clothing of any person operating on the system:

- Do not wear loose clothing that could get caught on parts of the system;
- Do not wear ties or other loose garments;
- Do not wear bulky rings or bracelets that could get caught on parts of the system.

Whenever necessary, further recommendations for use will be provided in the Manual with regard to preventive measures, personal protective equipment, the prevention of human error and any reasonably foreseeable prohibited behaviour.

It is, however, essential to follow the instructions below carefully:

- It is strictly forbidden to operate the single machines that make up the system automatically with the fixed and/or movable guards removed;
- It is strictly forbidden to inhibit the safety devices installed on the system;
- The low safety operations must be carried out strictly in accordance with the instructions given in the relevant descriptions;
- Any protective devices of the system removed for the purpose of low safety operations must be put back in place as soon as possible;
- The washing operations must be carried out with the electrical and compressed air separation devices disconnected;
- Do not alter parts of the system for any reason; in the event of malfunction due to non-compliance with the above, the manufacturer cannot be held liable for the consequences. We recommend that you contact the manufacturer directly to request any alterations;
- Clean the casing of the machines, the panels and the controls with soft cloths that are dry or have been dampened with a mild detergent solution; do not use any type of solvent, such as alcohol or petrol, as the surfaces may be damaged;
- Position the machines following the instructions given at the time of order and referring to the diagrams provided by the manufacturer; if this is not done, the manufacturer cannot be held liable for any issues.

The safety officer of the company that owns the machine is required to ensure that the following safety warnings are read and understood correctly. The warnings below are divided into:

Safety obligations concerning general and organizational safety indications.

Warnings that apply to and must be known **by all personnel**. Intended for operation with or near the installation;

Warnings for operators with instructions which the operators of the installation must observe to ensure use of the machine without endangering their own safety or that of other operators or of property.

Everyone who, for whatever reason, finds themselves working in the work area of the machine, must read and understand the safety warnings.

Unauthorized tampering/replacement of one or more parts or units of the machine, the use of accessories, tools, consumables other than the original ones or in any case those recommended by the manufacturer, may represent a risk of injury and relieve the manufacturer from civil and criminal liability. The machine has been designed in such a way that all safety devices do not pose any risk for the operator.

The operator is strictly forbidden to alter the technical or physical characteristics of the equipment or to use it for purposes other than those foreseen and documented.

The machine must always be used according to the standards of good practice and the law in force in each country, even if the country of use does not have specific regulations that apply to the specific sector.

The manufacturer **BICARjet® S.r.l.** may be consulted regarding the possibility of carrying out non-routine work cycles not expressly provided for; in which case, the manufacturer will make its resources and expertise available to the customer.

In the case of any use other than that envisaged in the order and tested during the acceptance test, to which the machine may be put during its operating life, the user and/or operator is held solely responsible for any failures, environmental damage and harm to persons and property.

Environmental conditions and careful routine maintenance play a particularly important role for the correct and reliable operation of the machine.

There must be no harmful or chemically aggressive and/or explosive vapours and/or gases in the environment, and no infiltration of dust the extent and quality of which could be harmful to the operator or to the machine.

Cleaning the area around the machine is crucial to safety.

Dust and fragments of the product being processed or other residues can make the floor slippery, creating dangerous conditions.

Both the worktops and the floor must be cleaned regularly, using suitable equipment to remove dust, fragments and residues and any kind of foreign bodies.

It should always be borne in mind that the use of any machine can pose an element of risk.

Always focus all your attention on what you are doing.

It is essential to always take all due care and be alert at all times.

A person who experiences any discomfort or physical malaise, even slight, which can reduce their degree of vigilance, must avoid starting the machine or using the aggregate or accessory equipment. The operator must avoid unsafe operations not foreseen by the work in progress, which could compromise their own balance.

The operator is advised to use clothing suitable for the work environment and the situation concerned.

If necessary, the operator is advised to use protective glasses and personal hearing protection.

The person in charge of the machine or maintenance must avoid wearing chains, bracelets and rings and use a net to hold back long hair.

With regard to personal protective equipment, the European Community has issued directives 89/686/EEC and 89/656/EEC.

Variations with respect to normal operation (increase in power absorption, temperature, vibrations, noise or signals from the safety system) are clear indications of incorrect operation.

To prevent malfunctions, which can directly or indirectly cause serious damage to people or property, the maintenance personnel must be informed as a matter of urgency. Any maintenance on the hydraulic and compressed air systems must be carried out only after having released the pressure inside the systems themselves.

To resolve any cause of failure or inconvenience inherent in any element of the machine, take all suitable precautions to prevent any possible damage to people and property.

1.6 RECOMMENDATIONS REGARDING LIGHTING AND VENTILATION OF THE PREMISES

The customer must ensure ambient lighting to avoid the presence of shaded areas and risk of annoying glare. The lighting must be adequate for the planned operations.

Lack of lighting could pose risks.

An optimal ventilation of the premises must also be guaranteed, with the possible use, if foreseen, of an appropriate suction system.

1.7 CONNECTIONS

1.7.1 ELECTRICAL CONNECTION

Electrical supply: 220 V 50 Hz 16A

Power: 3.2 kW

1.7.2 COMPRESSED AIR CONNECTION

Air supply: 6 (min) to 10 (max) bar

Power line: DN 15 mm (1/2")

The supply air must be dehydrated, de-dusted and free from lubricating oils.

1.7.3 WATER CONNECTION

Water supply: 3 (min) bar

Power line: DN 15 mm (1/2")

1.7.4 DRAIN CONNECTION

Connection to the non-hazardous industrial waste water drainage system according to *Annex V part III of Legislative Decree no. 152/06*

Wall drainage line: Ø 40 mm

1.8 SAFETY DEVICES



FAILURE OR NEGLIGENCE IN COMPLYING WITH THE FOLLOWING INSTRUCTIONS MAY CAUSE THE DEVICE TO MALFUNCTION, CAUSE DAMAGE OR INJURY TO THE USER



IN ORDER TO PREVENT THE RISK OF ELECTRIC SHOCK, ONLY CONNECT THE DEVICE TO GROUNDED SOCKETS



DO NOT USE THE DEVICE UNTIL YOU HAVE READ AND UNDERSTOOD THIS USER MANUAL IN ITS ENTIRETY



DO NOT MODIFY THE DEVICE
AND/OR ITS PARTS



USE OF THE DEVICE FOR PURPOSES OTHER THAN THOSE INDICATED IN THIS USER
MANUAL COULD EXPOSE THE USER TO DANGER



REPORT ANY SERIOUS ACCIDENT INVOLVING THIS DEVICE TO THE MANUFACTURER AND
TO THE COMPETENT NATIONAL AUTHORITY OF THE MEMBER STATE IN WHICH THE USER
AND/OR PATIENT LIVES

The **BICARjet® S.r.l.** lines have been designed and built to ensure safe and efficient operation. Despite this, some anomalous conditions of use (for example non-compliance with the technical parameters required for the use of the machine and/or non-compliance with the enclosed instructions) can cause danger for the operator and the machine itself.

The user and/or operator must carefully prepare the most suitable environmental structures to ensure the highest general operational safety for the operator, the machine and the environment.

All the normal precautions dictated by the rules of good practice and common sense must necessarily be considered and applied to protect the users themselves.

The machine is equipped with a series of safety devices designed to ensure the safety of the operator and of the system itself.

For the protection of operators, the following are envisaged:

- 1) work cabin to isolate the spray area from the work environment;

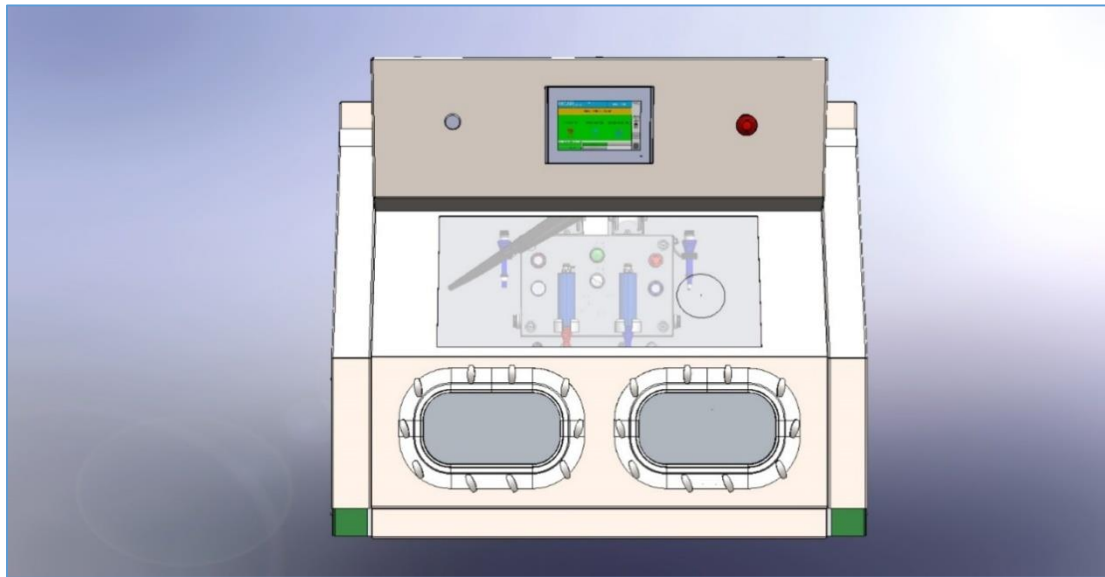

Fig. Work cabin

- 2) the mushroom-type emergency button, which is present both on the control panel inside the cabin and on the front of the cabin itself, which instantly interrupts the work cycle.

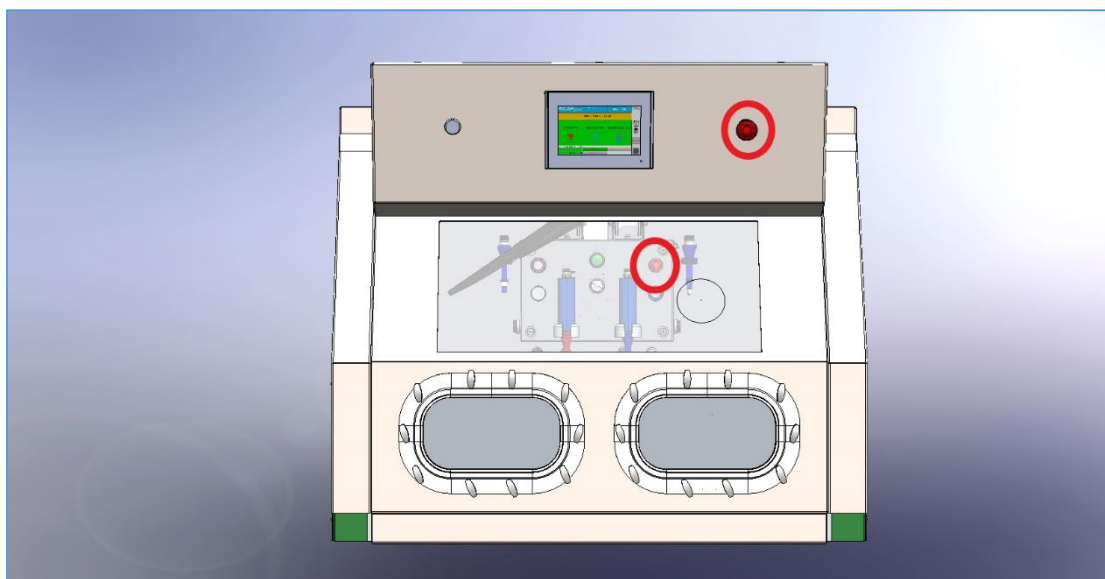

Fig. Emergency buttons

- 3) Sensitive edges stop movement of the doors instantly when closing if they encounter an obstacle. The slowness of movement also represents a source of safety as it allows the operator, who operates the doors, to stop them in time himself.

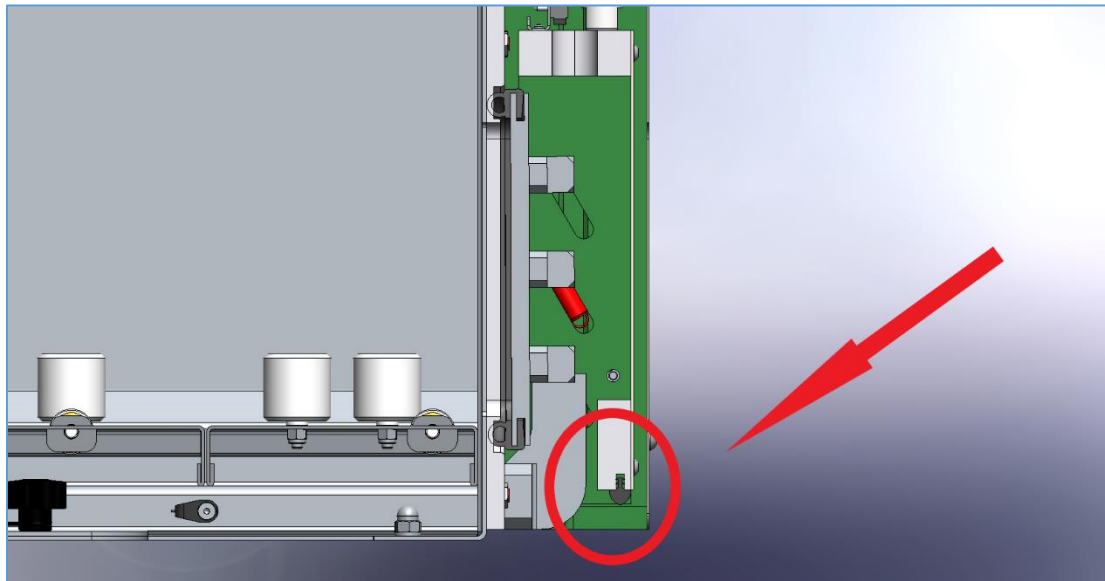

Fig. Sensitive edge

- 4) Visual indicators on the push-button panel inside the cabin with the following meaning:
- **FLASHING GREEN LIGHT (1), BLUE LIGHT (2) and BLUE BUTTON (3):** machine ready and waiting
 - **RED BUTTON (4) ON:** machine in lockout and alarm signal on the HMI panel

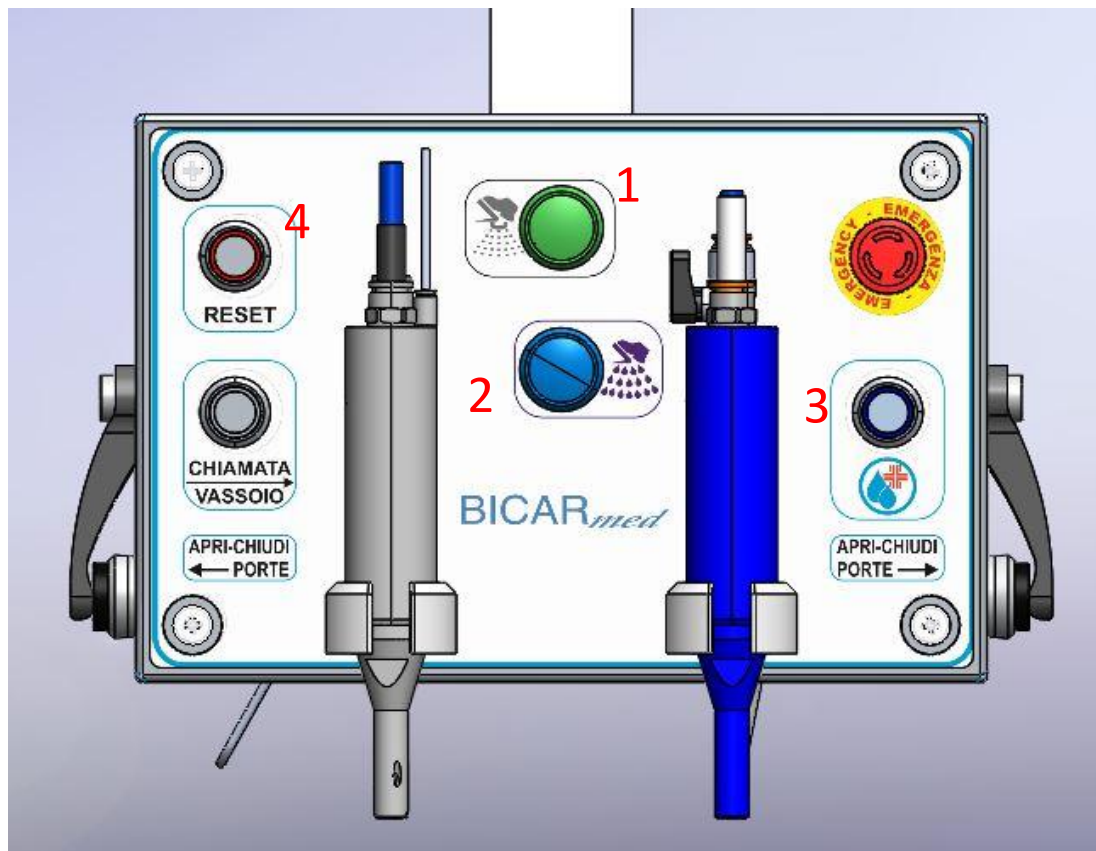

Fig. Visual indicators with alarm

- 5) the pedals that activate the functions of the device when pressed, but once released, instantly stop the spray in the cabin.

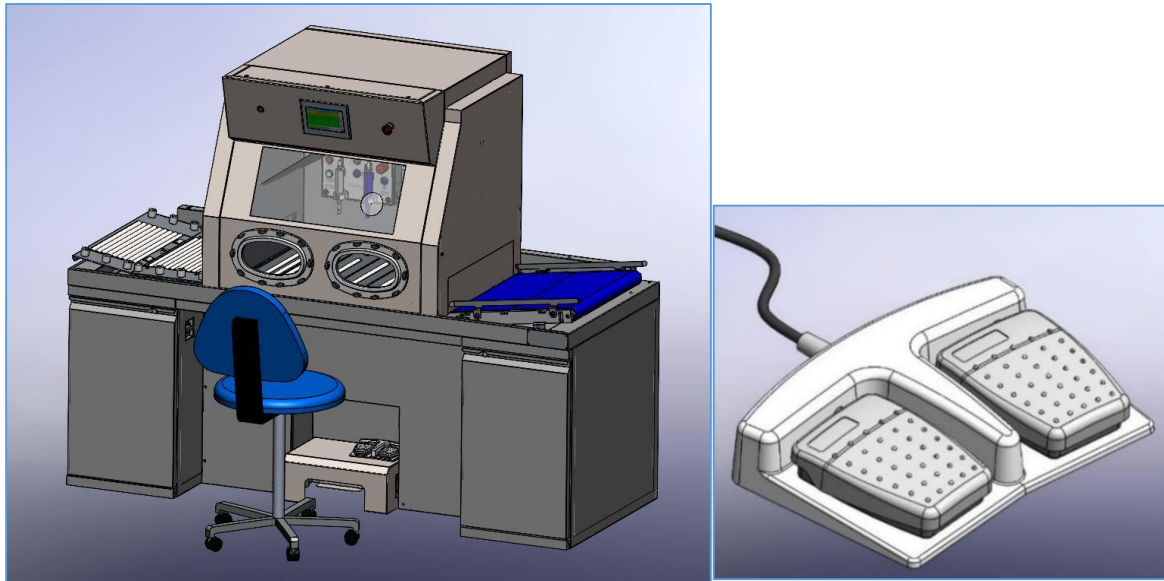

Fig. Pedal

- 6) the door sensors (integrated in the actuators that move the doors), which allow the cabin to be used only with the doors closed and stop operation of the cabin when the doors are opened, triggering an acoustic and visual signal on the HMI panel.

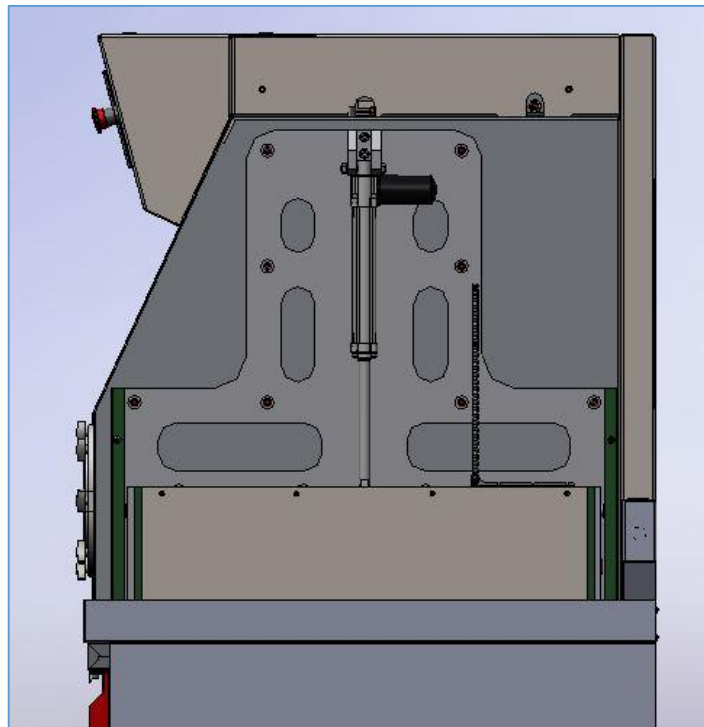

Fig. Door closing device

7) Safety signs on the machine



1.9 COMPOSITION OF THE DEVICE



THE USE OF ITEMS THAT ARE NOT PART OF THE SYSTEM DESCRIBED ABOVE OR NOT SUPPLIED WITH THE DEVICE MAY JEOPARDIZE ITS SAFETY AND PERFORMANCE.



If not all the items listed have been received, contact the manufacturer immediately

The **SAFE CleanBox** device for cleaning metal surgical instruments manufactured by BICARjet® S.r.l. and hereinafter referred to simply as the **SAFE CleanBox**, integrates a number of elements including:

- A washing cabin
- **SAFEKLINIC®** Bicarbonate System
- Drainage system
- Tray loaders (optional kit)

The **SAFE CleanBox** is designed for the specific cleaning of various types of **metal surgical instruments** by means of a mixture of air and pressurized water enriched with abrasive particles consisting of **SAFEKLINIC®** synthetic sodium bicarbonate.

The **SAFE CleanBox** machine consists of a bicarbonate feed unit that uses pressurized air and water to supply a suitably mixed solution of **SAFEKLINIC®** synthetic sodium bicarbonate in suspension, via suction, for cleaning the instruments in the cabin.

This unit consists of a number of pneumatic components that allow the bicarbonate to be sprayed in an optimised and controlled manner.

The central element is the **SAFE CleanBox** washing cabin, which directs the flow of bicarbonate under pressure without contaminating the surrounding environment with bicarbonate dust and any residues that may have been removed. This unit is fitted with two vertically opening doors that can be opened to put in and take out the trays containing the instruments to be cleaned. The cabin is fitted with a glass panel that allows the operator to monitor the work in progress and two full-arm, sealed gloves that allow operators to insert their hands from the outside and carry out the operations necessary for cleaning the instruments. Inside the cabin, there is a special handpiece, from which the pressurised air-water-bicarbonate mixture comes out, and a second handpiece from which a jet of water comes out to facilitate cleaning and the removal of excess bicarbonate. The by-product from cleaning, consisting of bicarbonate and removed residues, is collected in a sealed tank under the cabin and is extracted directly. The third element of the line is the collection and drainage system for the collection and evacuation of dust and water mist present inside the cabin. Dust and mist are extracted from the cabin by the forced ventilation system and conveyed to this unit where the dust is slowed down and transferred to a collection container, and the air is filtered and expelled by the filter. The powder in the collection container is mixed with a jet of water and expelled automatically via an independent pump that conveys the processing residues directly into the sewer system.

The **SAFE CleanBox** machine is fitted with a control panel located in the lower compartment on the left of the machine. It is mounted on a series of guides for easier maintenance. The operating modes are controlled via a touch screen located above the cabin. Inside it, and therefore within direct reach of the operator with gloves on, some commands and signals are sent back to control the operating conditions, including the red mushroom-head emergency stop button. The two handpieces are operated by a double pedal unit on the floor under the cabin. There is also an emergency button outside the cabin near the touch-screen.

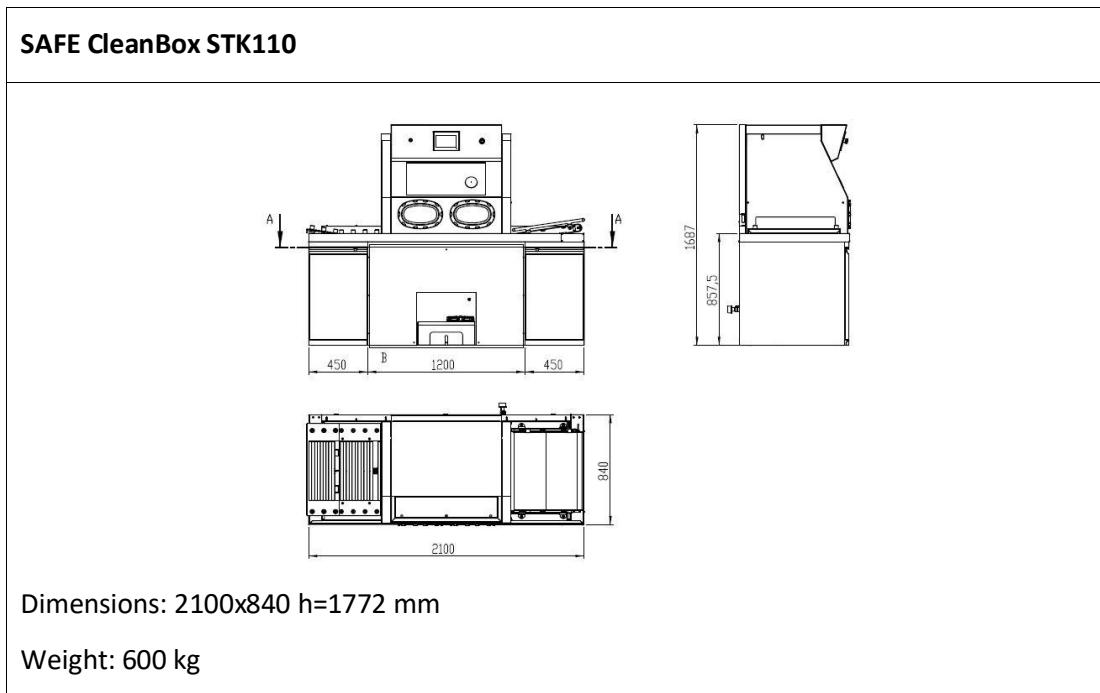

WASHING CABIN

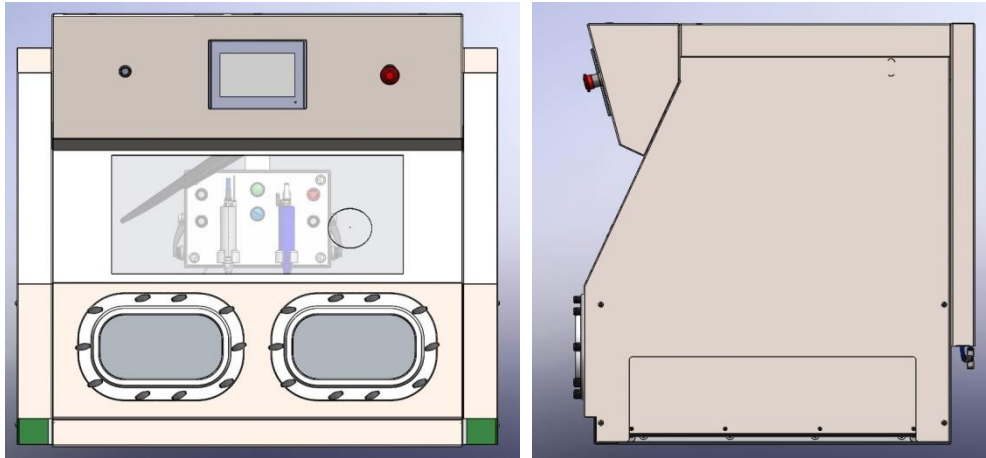

Dimensions: 988x832 h=890 mm

Weight: 100 Kg

INTERNAL PUSH-BUTTON PANEL

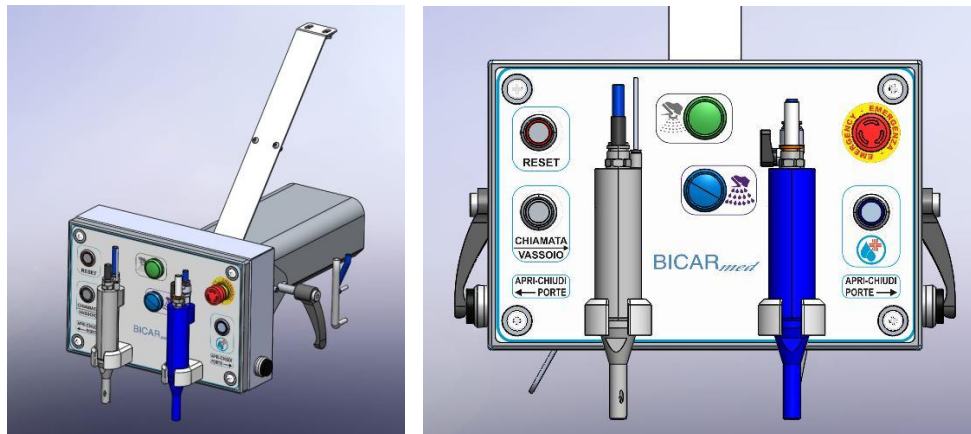

Dimensions: 396x97 h 316 mm

Weight: 5 kg

BICARBONATE SYSTEM

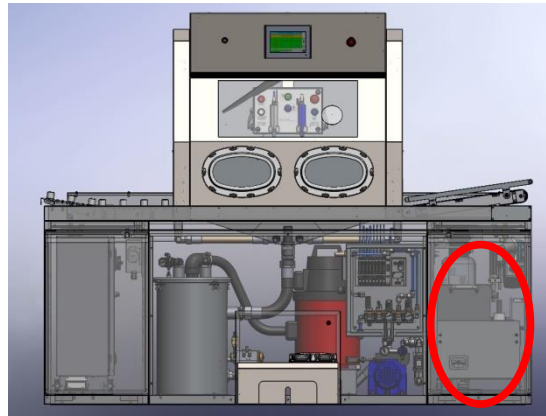
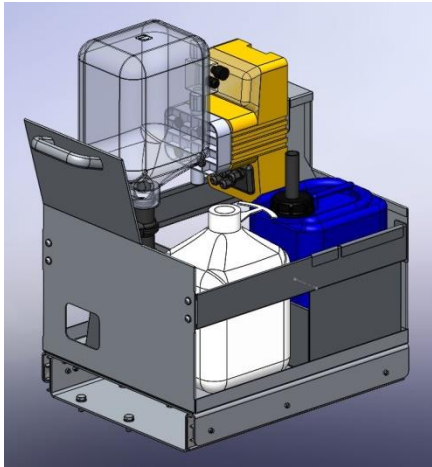

Dimensions: 353x212 h=541 mm

Weight: 20 kg

DRAINAGE SYSTEM

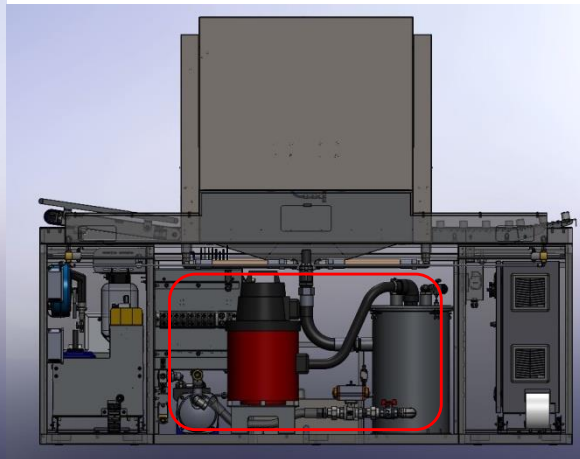
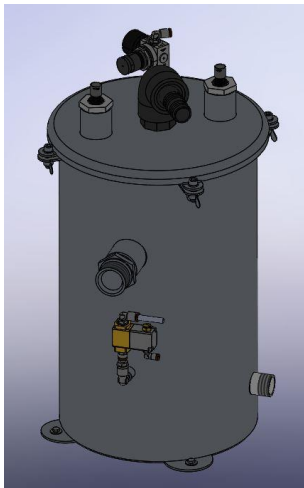

Dimensions: 435x605 mm

Weight: 10 kg

ELECTRICAL PANEL

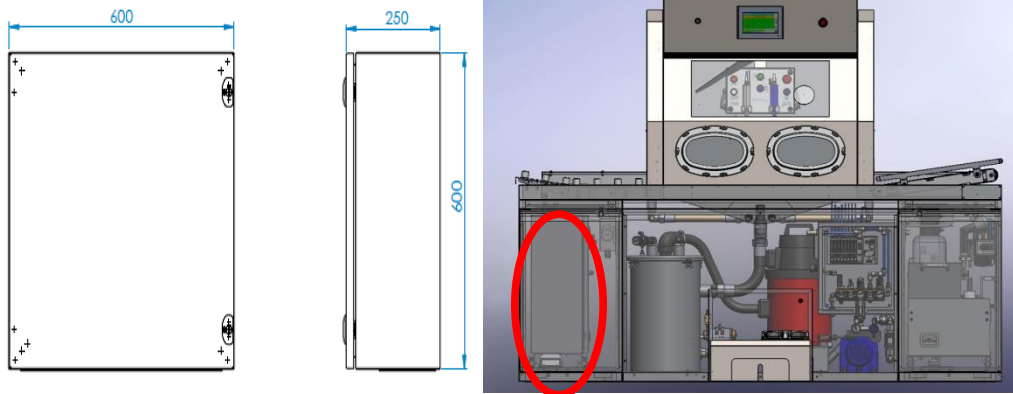

Dimensions: 600x250 h 600 mm

Weight: 35 kg

INFEEED ROLLER CONVEYOR

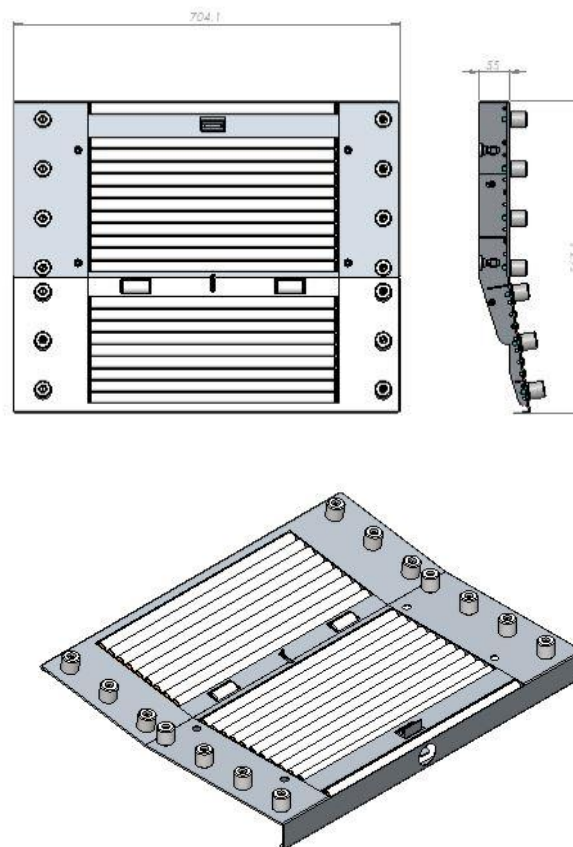

Dimensions: 704x567 h 94 mm

Weight: 6 kg (each)

CONVEYOR BELT

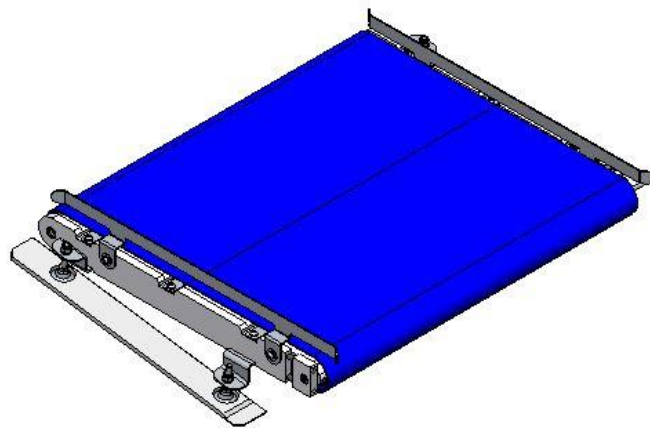
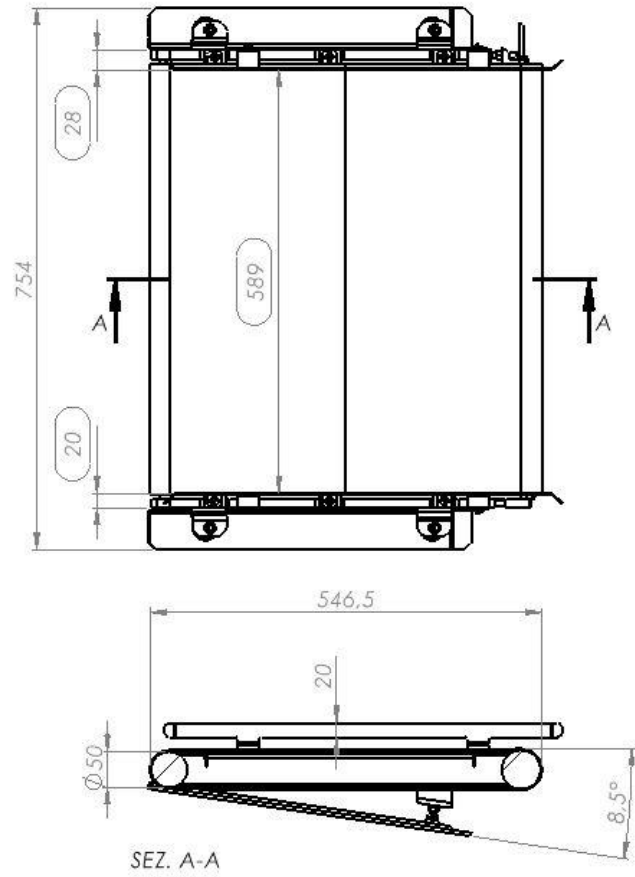

Dimensions: 754x550 h 157 mm

Weight: 29 kg (each)

SAFEKLINIC®

The inert product SAFEKLINIC® (bicarbonate) does not pose any danger to humans and the environment; it is advisable, however, to observe the following recommendations. During use and loading, unloading and cleaning of both the pieces to be cleaned and the aggregates and processing residues.



2 INSTALLATION



THE DEVICE MUST BE INSTALLED ONLY BY SPECIALIZED TECHNICAL PERSONNEL DULY TRAINED AND AUTHORIZED BY THE MANUFACTURER



DO NOT POSITION THE DEVICE IN SUCH A WAY THAT IT IS DIFFICULT TO UNPLUG FROM THE POWER SOCKET OR ACTIVATE THE CIRCUIT BREAKER



ENSURE THAT THE USE ENVIRONMENT MEETS THE REQUIREMENTS SET OUT IN THE "ELECTROMAGNETIC COMPATIBILITY" CHAPTER BELOW

Installation must be entrusted solely to qualified personnel:

those persons who have completed specialization courses, training courses, etc., and have experience in installing, commissioning and servicing, repairing and transporting machines produced by **BICARjet®**. A qualified technician, able to operate the system under normal conditions, to have it work with maintained action control with the guards deactivated, being assigned to all operations of an electrical nature to make adjustments and to perform maintenance and repairs. This technician can operate on live parts in electrical switchboards and junction boxes.

1) LAYING ON THE GROUND:

Place the machine on a flat and even surface according to the requirements at the workplace, to ensure correct horizontal positioning of the cabin.

Model STK 110

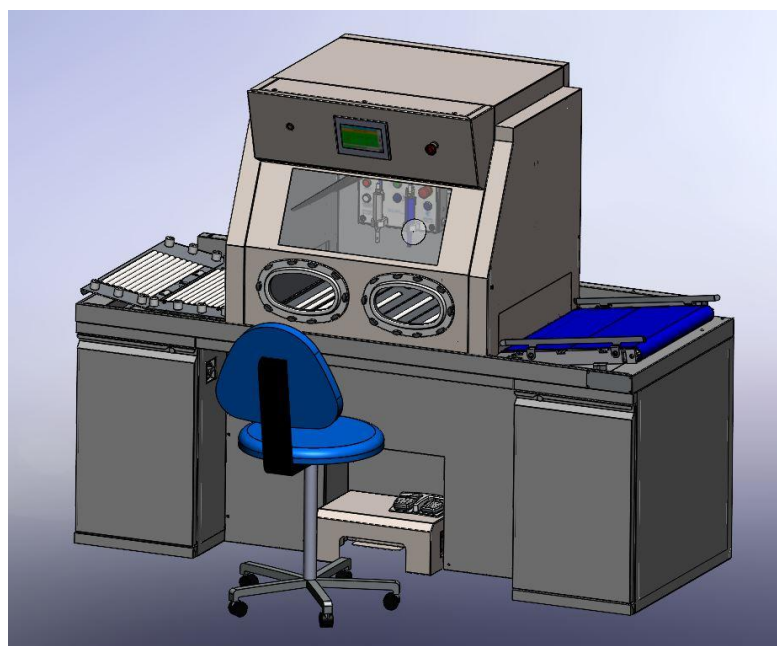

2) CONNECTIONS:

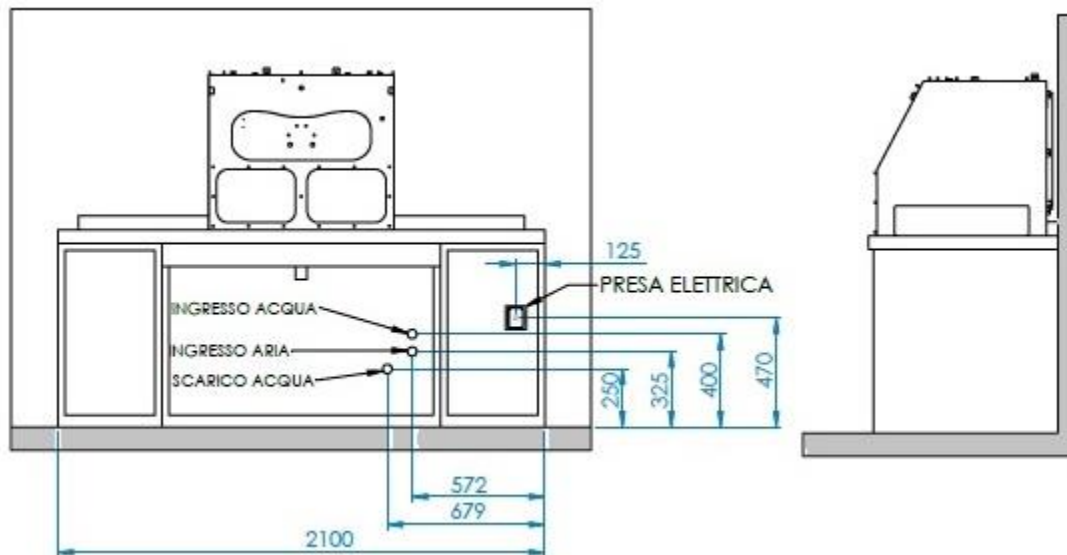

- ELECTRICAL

Connect the electrical socket to the **230 V 50 Hz 16 A** mains panel.

- AIR

Connect the compressed air delivery hose to the mains supply unit with quick coupling. DN 15 mm (1/2")

- WATER

Connect the water delivery hose to the mains supply unit with quick coupling. DN 15 mm (1/2")

- DRAIN

Connect the $\varnothing 40$ mm drain hose between the centrifugal pump and the drain line. It is essential to always ask the local health authorities for the current rules on drains at the place of use. The draining, retention and storage of part or all of the processing residues, whether liquid and/or solid, is at the complete care and responsibility of the user.

2.1 LIFTING AND TRANSPORT

The machine is packed inside a wooden crate.

Handling must be carried out with a forklift truck or transpallet.
Slings must NOT be used for lifting.



After opening the box, the machine must be lifted with special equipment designed for moving furniture. Model FM 60 –FERPLAST- included.

The machine can therefore be moved using suitable lifting equipment or by placing two trolleys / sliding blocks under the bench, at the junctions between the central and side sections.

These devices must be returned to Bicarjet after installation.



2.2 SET-UP OF USE ENVIRONMENT

The following operations are the responsibility of the **user**:

1. identification of the work area of the system and preparation before installation in such a way as to optimise the ergonomics and safety of the workplace. In particular, it is recommended to leave enough space around the work and passage areas to allow easy loading/unloading, maintenance and adjustment operations. Furthermore, the following general requirements should be taken into account when identifying the work area:
 - Place covered and protected from rain or bad weather.
 - Protection from splashes, humidity and direct sunlight.
 - Connected, smooth, flat and resistant floor.
 - Ambient temperature between +5 and +40 °C.
 - Ambient relative humidity between 20 and 80%.
 - Well ventilated room.
 - Place away from electrical systems and free from objects that could be damaged, as well as free from other people.

- When choosing the place of installation, consider the type of lighting; this must be diffused and not reflect off the glass of the window of the cabin, causing glare.
- 2. Any ducts for the passage of:
 - electrical cables;
 - hoses for the supply of compressed air;
 - any centralized drainage systems;
 - near the power supply unit and the electrical panel of the machine.

3. Wiring for the supply of electrical power and compressed air, up to the control panel and with power rating matching that on the data plate provided by **BICARjet® S.r.l.**, including earth connection.
 - Cordon off the work area to prevent unauthorized access.

2.3 PREPARATION FOR INSTALLATION

There must be sufficient space for manoeuvring the means of transport and for lifting of the device, in order to guarantee the safety of the operators entrusted with installation.

2.3.1 PREPARATION OF THE ELECTRICAL SYSTEM

The following are the responsibility of the **specialized technical staff**:

Electrical supply: **230 V 50 Hz 16 A**

Power: **3.2 kW**

The connection to the electrical supply network must be carried out by specialized and qualified personnel in accordance with the wiring diagram and the provisions of the Laws and/or Technical Standards in force pertaining to safety in the workplace and electrical systems. Appropriate safety devices must be provided for its operation according to the Occupational Safety standards.

2.3.2 PREPARATION OF THE COMPRESSED AIR SYSTEM

Air supply: **6 (min) bar / 10 (max) bar**

Power line: DN 15 mm (1/2")

The supply air must be filtered to min. 50 microns, and must be dehydrated and free of dust and lubricating oils.

It should be possible to switch off the power supply socket by inserting a manual closing lever.

2.3.3 PREPARATION OF THE WATER SYSTEM

Water supply: **3 (min) bar**

Power line: **DN 15 mm (1/2")**

2.3.4 PREPARATION OF THE DRAINAGE SYSTEM

Connection to the non-hazardous industrial waste water drainage system according to *Annex V part III of Legislative Decree no. 152/06*

Wall drainage line: **Ø40 mm**

2.3.5 PREPARATION OF THE WORK AREA

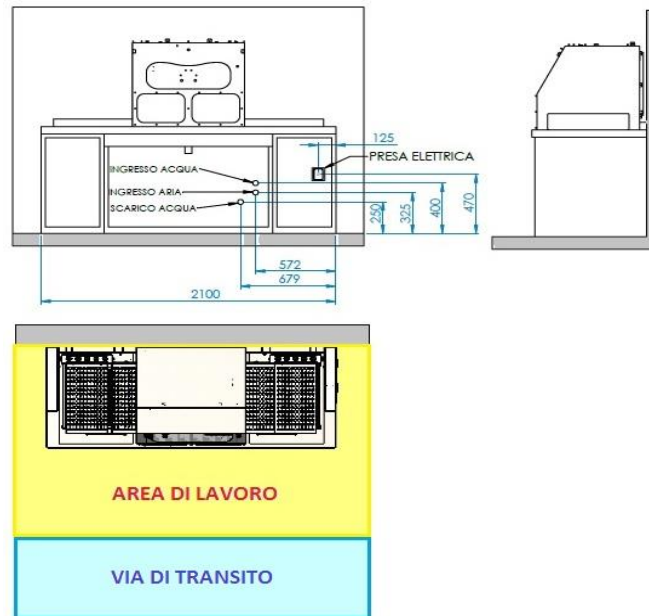

In order to guarantee maximum safety, it is necessary to identify with horizontal signs the areas not to be accessed by exposed people, the loading and unloading areas, and the work area for the operator as indicated in the layout drawing.

2.4 POST-INSTALLATION CHECKS

NO-LOAD TESTS FOR INITIAL START-UP:

qualified personnel: those persons who have completed specialization courses, training courses, etc., and have experience in installing, commissioning and servicing, repairing and transporting the machine produced by BICARjet®. **Qualified technician:** the person responsible for all electrical adjustments, maintenance and repairs. This technician can work on live parts in electrical switchboards and junction boxes

CHECKS TO CARRY OUT ON MODEL STK 110 (indicate N/A where the check cannot be carried out)				
No.	PRELIMINARY CHECKS	RESULT		
		Pos.	Neg.	N/A
	before supplying electrical power to the system, check:			
1	the integrity and stability of the system			
2	the integrity of the electrical, compressed air, water and drain connections			
3	the mains air and water wall valves do not leak			
4	the safety systems are intact and have not been triggered			

5	the integrity of the hoses in the cabin			
6	the integrity of the conveyor belt's electrical and mechanical connections			
No.	OPERATION CHECKS	RESULT		
	supply electrical power to the system and check:	Pos.	Neg.	N/A
1	switching on of the touch panel and loading of the program			
2	switching on of the lights inside the cabin			
3	switching on of the indicator lights of the push-button panel inside the cabin			
4	the absence of alarms/signals at the panel			
5	the presence of air/water at the panel			
6	operation of the emergency buttons			
7	operation of the sensitive edges of the doors			
8	operation of the conveyor belt			
9	operation of the doors			
10	loading the SAFEKLINIC bottle			
11	loading the SANITIZER bottle			
12	operation of spray handpieces by pressing the pedals			
13	operation of the wiper/ wiper water by pressing the pedals			
14	Absence of leaks			
15	Operation of aspirator			
16	Operation of drain pump			
17	integrity and operation of the infeed roller conveyor			

MAINTENANCE REPORT
SYSTEM STATUS/CONDITION

ADJUSTMENTS:

The **STK 110** machine delivered by **BICARjet® S.r.l.** is already set up and ready for operation.

Adjustments are only necessary during the service life when maintenance is carried out (see chapter 4: Maintenance).

It is recommended that these operations be carried out only by qualified personnel, or by the Manufacturer's personnel.

3 METHOD OF USE



CHECK THE INTEGRITY OF THE DEVICE BEFORE PROCEEDING WITH THE NEXT STEPS

3.1 SWITCHING ON THE DEVICE

SWITCHING ON:

- Make sure that the emergency buttons on the electrical panel are released.
- Visually check the presence of **SAFEKLINIC®** inside the right compartment, and load it if necessary.
- Turn on the main switch by turning clockwise the red selector at the bottom under the bench on the left wall of the central compartment, bringing it to the vertical position I-ON.
- Visually check that the interior lights of the cabin are on.
- Visually check the visual indicators on the push-button panel inside the cabin with the following meaning:
 - GREEN LIGHT, BLUE LIGHT and BLINKING BLUE BUTTON:** machine ready and waiting
 - RED BUTTON ON:** machine in lockout and alarm signal on the HMI panel
- Visually check through the glass that the working hoses of the guns inside the cabin are free and intact.
- Wait for the program to load completely, following the progress bar on the screen itself.
- The control and programming panel will light up on the home screen, confirming that it is ready to start the machine.

PERSONAL PROTECTIVE EQUIPMENT (PPE):
Nitrile gloves

3.2 START-UP, OPERATION - LOGIN

In order to use the STK 110 device, it is necessary to log in with the cards supplied.

The STK 110 device is delivered with 10 cards to enable the machine, 9 for operators and 1 for a head of department. It will be the employer's responsibility to keep track of assignation of the cards to the operators and the association of each one to the personnel specially trained to use the machine.

The cards supplied for operating users, specially trained to use the machine, are given the following code:
01, 02, 03, 04, 05, 06, 07, 08, 09

The card for the head of department, who is also specially trained to use the machine, is named as follows:
DEPARTMENT

HOW TO LOG IN:

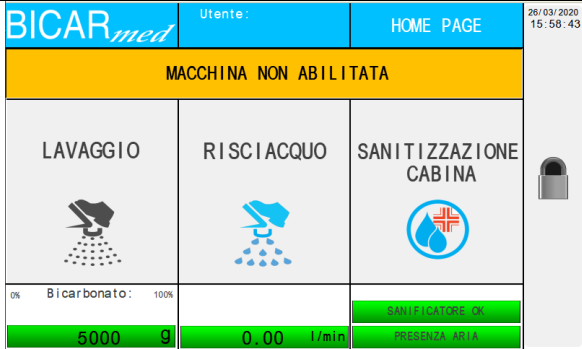
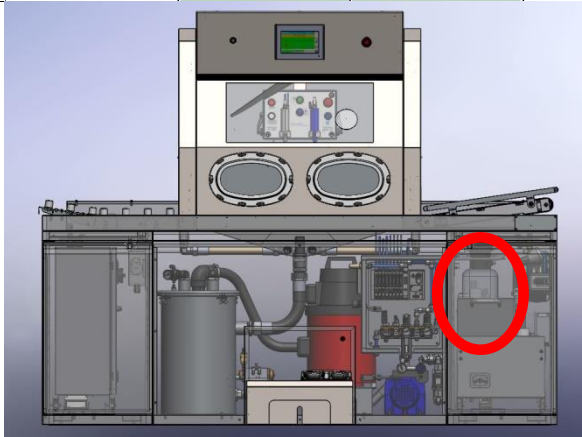
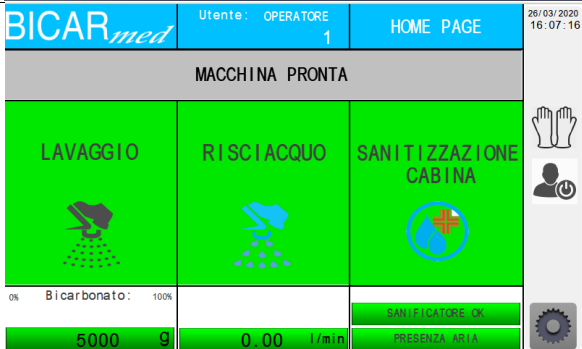
<p>At the time of login, the monitor communicates that the machine is not enabled for use.</p>	
<p>Open the compartment on the right of the bench. Hold the card against the RFID sensor located at the top left.</p>	
<p>Check access on the monitor.</p>	
<p>The machine is now ready to operate.</p>	

HOW TO LOG OUT:

The device automatically logs out an operator after 5 minutes of inactivity of the machine.

<p>To log out, press the highlighted icon on the monitor.</p>	
---	--

3.2.1 CREATION OF NEW OPERATOR

CREATION OF NEW OPERATOR WITH CARD

This operation can be carried out only by a Head of Department.

<p>Log in as a head of department.</p>	
<p>Press the impostazioni (settings) icon.</p>	
<p>Press the sistema (system) key.</p>	
<p>Press the scrittura tag rfid operatore (write operator RFID tag) key.</p>	

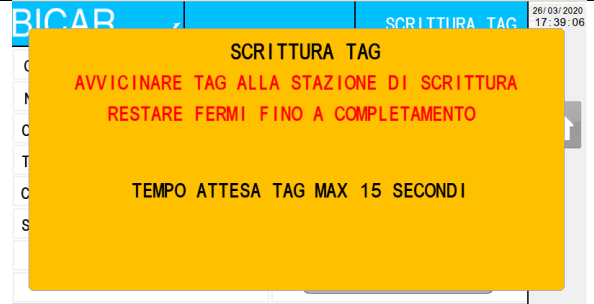
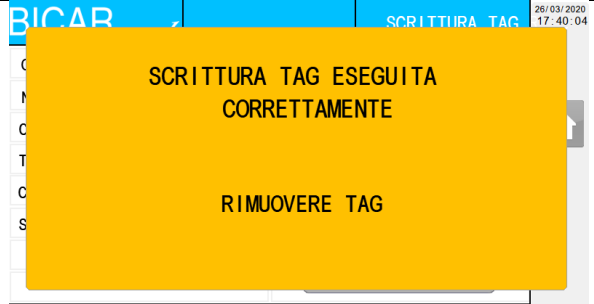
<p>Select the operator level with the key and write the new identification number of the card.</p>	
<p>At this point, hold the new card up against the RFID reader located in the compartment on the right of the bench.</p> <p>Writing of the new card is instantaneous.</p>	
<p>Check the monitor for the following message:</p>	
<p>Creation of the new operator is completed.</p>	

3.2.2 OPERATION OF THE DEVICE:

At this point the operator can sit in front of the cabin and insert his arms into the gloves using the "guanti" (gloves) function on the panel:

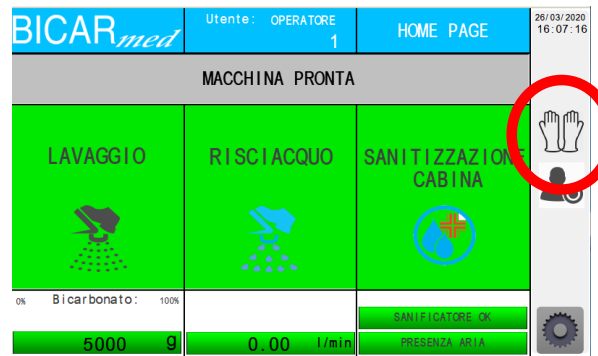

The instructions for using the HMI panel are given in section 10 of this manual, where the different screens available and the functions that can be activated are shown.

3.2.3 OPERATION OF THE CONVEYOR BELT.

In the SAFE CleanBox STK 110 version, the outfeed conveyor belt is automatically activated for a pre-set time when the doors are opened. Any anomalies are shown on the HMI panel.

The STK 110 can also be activated by pressing the “CHIAMATA VASSOIO” (TRAY CALL) button on the push-button panel.

The correct use of the SAFE Clean BOX requires the operator to initially insert an empty tray inside the cabin on which to place the treated material until all the dirty instruments have been cleaned.

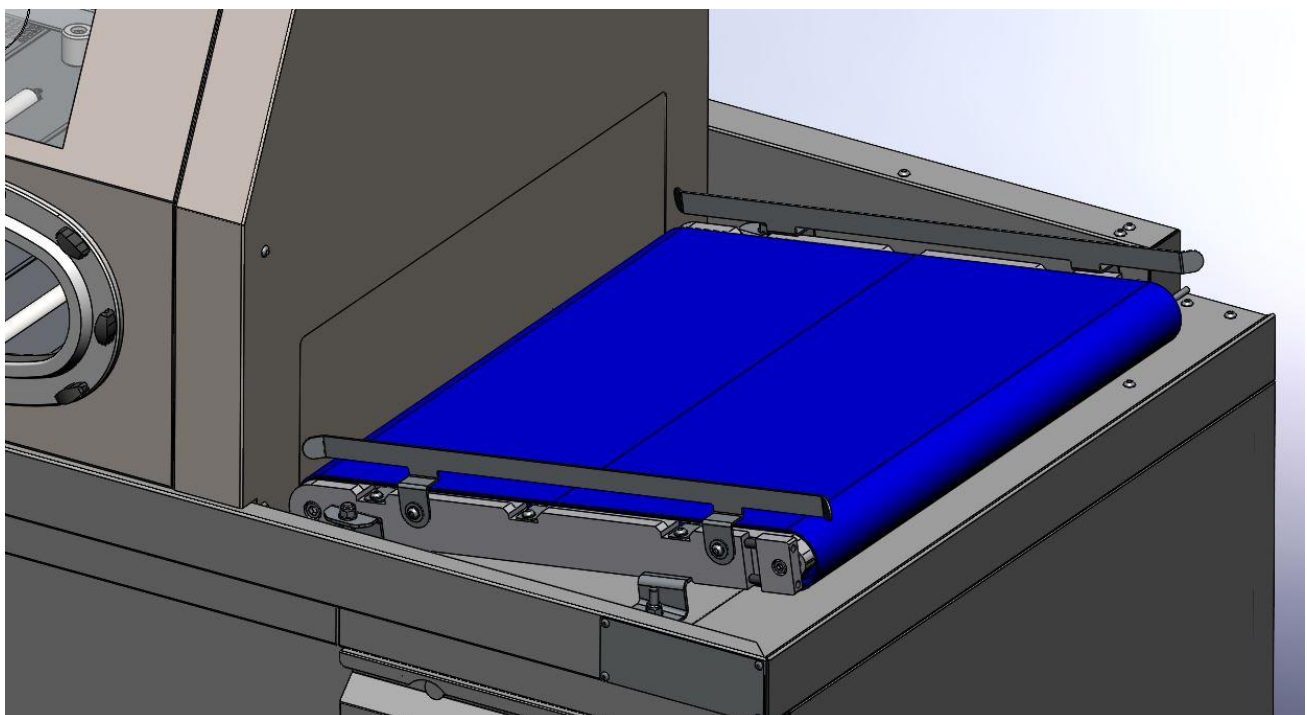

TRAY OUTFEED AND CONVEYOR BELT ACTIVATION:

The seated operator, with both hands in the gloves of the SAFE CLEAN BOX, can open the doors by pressing and holding the “porte” (doors) buttons located on the side of the push-button panel inside the cabin.

The message “porte aperte” (open doors) will appear on the HMI panel.

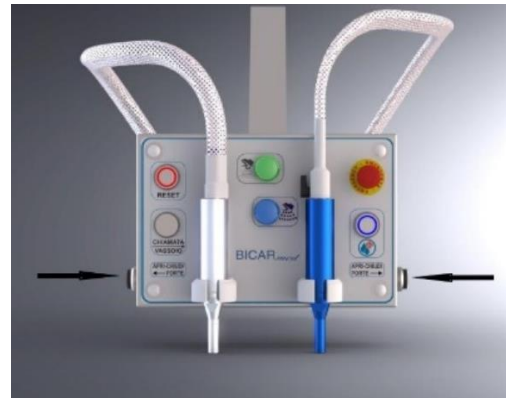

Now that the doors are fully open, the tray can be guided towards the outlet door so that the conveyor mat grips the tray and pulls it out of the cabin.

If the conveyor stops, it can be reactivated by pressing the “CHIAMATA VASSOIO” (TRAY CALL) button.



Close the doors by holding down the "porte" (doors) buttons located on the side of the push-button panel inside the cabin until they are closed.



If the doors are not closed correctly, the message “porte aperte” (open doors) continues to be shown on the panel and the sprays will not be activated for safety reasons.

3.2.4 START CLEANING OF THE INSTRUMENTS

Put your hands in the special gloves. (you must already have put on protective gloves as indicated in the PPE table).

You can use the Air, Water and **SAFEKLINIC**® spray handpiece (grey with grey icon) fixed on its support or pulled out.

Firmly grip the instrument to be treated with both hands.

Press the left pedal to operate the white air, water and **SAFEKLINIC**® handpiece.

The "lavaggio" (washing) icon on the HMI panel turns orange to indicate that washing is enabled.

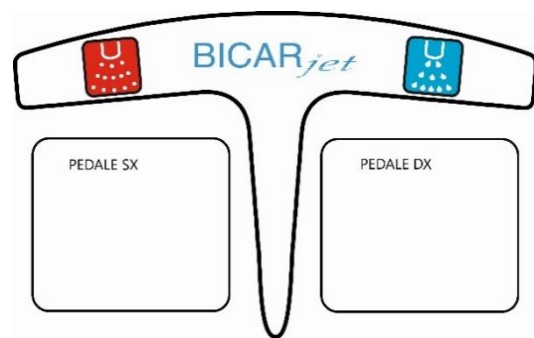

Monitor screen in washing mode.

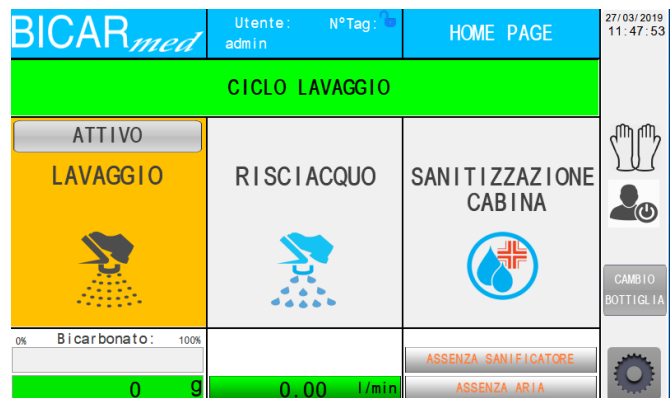

This function is activated only when the doors are closed.

Releasing the foot from the pedal, the washing function will stop automatically, interrupting the jet from the handpiece.

When the pedal is released, the lights on the push-button panel start flashing again. This means that the device is ready for a new function or to repeat the previous one.

FOLLOW THE PROCEDURE BELOW USING THE AIR JET AND BICARBONATE FOR TREATING THE INSTRUMENTS IN ORDER TO ENSURE CORRECT USE OF THE SAFE CLEAN BOX AND SATISFACTORY CLEANING.

3.2.5 INSTRUMENT TREATMENT PROCEDURE

Keep a minimum distance of 5 to 10 cm between the spray nozzle and the instrument to be treated.
Cover all surfaces of the instrument to be treated with the jet of SAFEKLINIC® .
Smooth and flat surfaces can be simply passed in a gradual manner under the jet of SAFEKLINIC® . Hold pivot points and joints under the jet of SAFEKLINIC® for at least 10 seconds and turn the instrument to allow the jet to cover the entire surface.
<u>IMPORTANT:</u> <u>WE RECOMMEND USING THE MAGNIFYING GLASS ON THE GLASS PANEL TO INSPECT THE INSTRUMENT THAT HAS JUST BEEN TREATED, IN ORDER TO INSTANTLY IDENTIFY ANY REMAINING TRACES OF DIRT.</u>
<u>IMPORTANT:</u> <u>RINSE ALL THE TREATED INSTRUMENTS (USING THE BLUE HANDPIECE), BOTH INSIDE THE CABIN AND ONCE THEY ARE TAKEN OUT.</u>

3.2.6 INSTRUMENT RINSING PROCEDURE

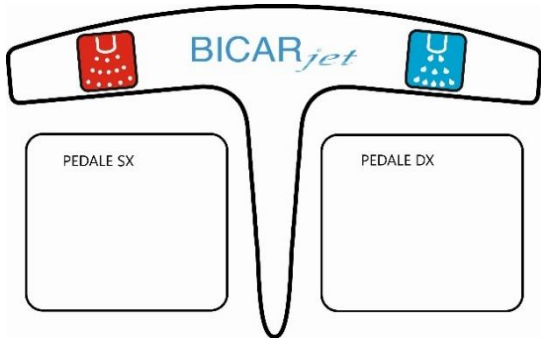
Each instrument treated with SAFEKLINIC® requires a rinse to eliminate any residual product.	
You can use the blue air and water spray handpiece fixed on its support or pulled out.	
Firmly hold the instrument that has been treated with both hands.	
<p>Press the right pedal to operate the blue air and water handpiece.</p> <p>The rinsing icon on the HMI panel turns orange to indicate that rinsing is enabled.</p>	

Monitor screen in rinsing mode.			
	<p>The RISCIAQUO (rinsing) function can be activated only with the doors closed by pressing the right pedal.</p> <p>Releasing the foot from the pedal, the washing function will stop automatically, interrupting the jet from the handpiece.</p> <p><i>When the pedal is released, the lights on the push-button panel start flashing again. This means that the device is ready for a new function or to repeat the previous one.</i></p>		

3.2.7 INSTRUMENT BLOWING PROCEDURE

It is possible to blow compressed air on the treated instruments by closing the water tap located above the blue handpiece.



DURING CLEANING AND RINSING OPERATIONS, HANDLE THE INSTRUMENTS TO BE TREATED WITH CARE, ESPECIALLY IF THEY ARE POINTED OR SHARP.

IMPORTANT:

BEFORE PROCEEDING WITH SANITIZATION OF THE CABIN, CHECK OPENING OF THE WATER TAP LOCATED ABOVE THE BLUE HANDPIECE, OTHERWISE THE DEVICE WILL SIGNAL AN ERROR.

3.2.8 CABIN SANITIZATION PROCEDURE

1) START:

The SANITIZZAZIONE CABINA (cabin sanitization) function can be activated only with the doors closed by



pressing the button on the internal push-button panel.

A message will appear on the HMI panel to confirm the function: if the cabin is free from objects, press the sanitization button again and start the procedure; otherwise, if you do not want to proceed, press RESET on the push-button panel to cancel the operation.

IMPORTANT:

CHECK OPENING OF THE WATER TAP LOCATED ABOVE THE BLUE HANDPIECE.

2) CLEANING OF THE CABIN:

IMPORTANT:

THE PURPOSE OF THE CLEANING PHASE IS MECHANICAL REMOVAL (WITH A JET OF PRESSURIZED WATER) OF ANY SOLID PROCESSING RESIDUE IN ORDER TO BETTER PREPARE THE SURFACES AND ENSURE EFFECTIVE DISINFECTION TREATMENT.

IN THIS PHASE, PRESSURIZED WATER WILL BE SPRAYED AUTOMATICALLY FROM THE BLUE HANDPIECE.

Remove the blue handpiece from its support and direct it upwards in the cabin.

Spray the pressurized water at all 4 upper edges, then move down the rear and front vertical edges of the cabin.

Spray water at the gloves, cleaning each one in alternation. Starting from the point of contact between the glove and the flange on the upper part, move towards the apex of the glove covering the entire surface. Repeat this operation starting from the bottom. Change hands and repeat the operation with the glove opposite the hand.

Spray the pressurized water at each internal surface of the cabin and make sure that any processing residue has been removed.

Spray the pressurized water at each surface of the support bracket of the push-button panel and at the push-button panel itself.

Carefully clean each individual roller conveyor, always making sure that any residue has been removed.

3) SANITIZATION OF THE CABIN:

IMPORTANT:



THIS PROCEDURE IS MANDATORY AND MUST BE CARRIED OUT FOLLOWING EACH STEP IN THE CORRECT SEQUENCE, IN ORDER TO GUARANTEE THE REDUCTION OF BIOLOGICAL RISK.

MAKE SURE TO COVER EVERY SINGLE INTERIOR SURFACE OF THE CABIN WITH THE SOLUTION.

DURING THIS PHASE, A SOLUTION OF WATER AND SANITIZER WILL BE SPRAYED AUTOMATICALLY.

A MESSAGE ON THE HMI PANEL AND AN ACOUSTIC SIGNAL ALERT TO THIS STEP.

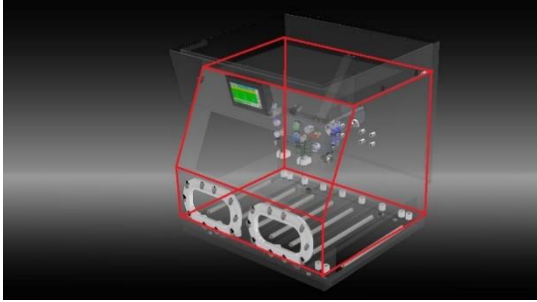
IF IT IS NOT POSSIBLE TO SANITIZE DUE TO ANOMALIES OR ALARMS, THE INSIDE OF THE CABIN MUST BE SANITIZED MANUALLY USING A SPRAY. FIRST CLEAN THE INSIDE OF THE CABIN WITH THE JET OF PRESSURIZED WATER, SPRAY AS PER THE PROCEDURE, WAIT FOR THE CONTACT TIME AND THEN RINSE.

ACTION	IMAGE	TIME
Remove the blue handpiece from its support and direct it upwards in the cabin.		
Spray the solution along all 4 upper edges, then move down the rear and front vertical edges of the cabin.		15"
Spray the solution and carefully cover all flat surfaces of the cabin (in order): <ul style="list-style-type: none"> - Upper - Rear - side (pay attention and cover the entire edge of the doors with solution) - front (glass) 		15"

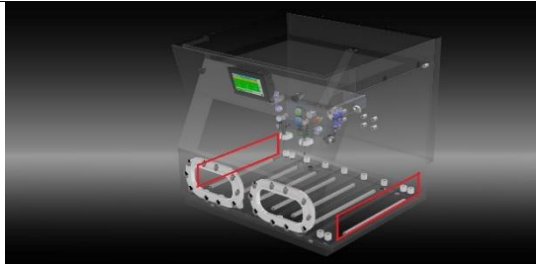
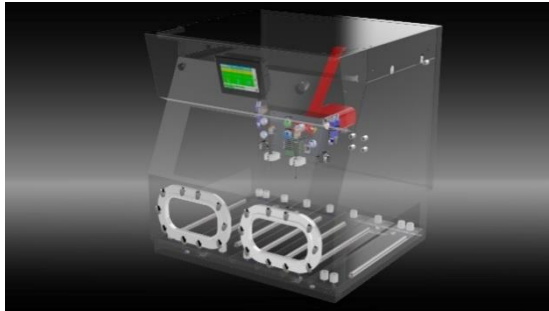
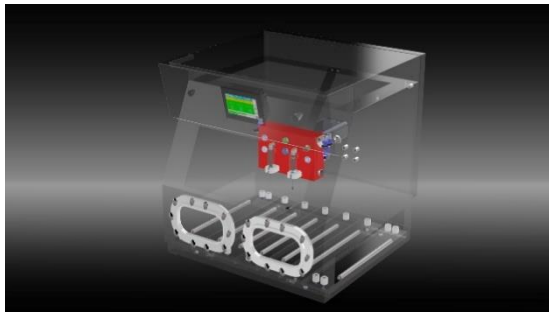
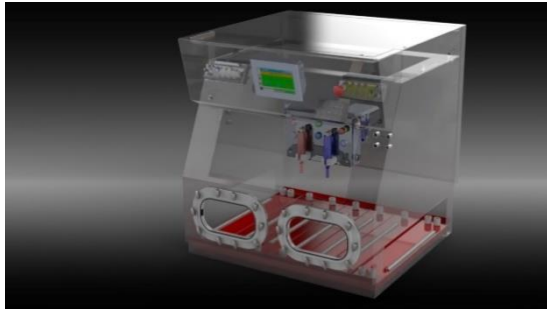
		
<p>Spray the solution and cover the upper and lower surface of the support bracket on the back of the push-button panel.</p>		<p>5"</p>
<p>Spray the solution and cover all the surfaces of the push-button panel (in order):</p> <ul style="list-style-type: none"> - Upper - Side - Front - Lower 		<p>15"</p>
<p>Spray the solution downwards, covering each roller conveyor with movements in a forward-backward direction.</p>		<p>10"</p>
<p>Spray the solution at the gloves, cleaning each one in alternation. Starting from the point of contact between the glove and the flange on the upper part, move towards the apex of the glove covering the entire surface. Repeat this operation starting from the bottom. Change hands and repeat the operation with the glove opposite the hand.</p>		
<p>4) CONTACT TIME:</p>		
<p>On the HMI panel, once the spray of water and sanitizer is finished, a timer called the contact time for the chemical action of the solution will appear. During this phase the machine disables all functions.</p> <p>The contact time ends with an acoustic signal.</p>		

5) RINSING THE CABIN:

IMPORTANT:

RINSING OF THE CABIN IS ESSENTIAL TO ENSURE THE PROPER REMOVAL OF CONTAMINANTS.

TO PROCEED WITH THIS PHASE IT IS NECESSARY TO PRESS THE CONFIRMATION, AS INDICATED BY THE HMI PANEL, ON THE INTERNAL PUSH-BUTTON PANEL.

PRESSURIZED WATER IS THEN SPRAYED AUTOMATICALLY FROM THE BLUE HANDPIECE.

Remove the blue handpiece from its support and direct it upwards in the cabin.

Spray the pressurized water at all 4 upper edges, then move down the rear and front vertical edges of the cabin.

Spray water at the gloves, cleaning each one in alternation. Starting from the point of contact between the glove and the flange on the upper part, move towards the apex of the glove covering the entire surface. Repeat this operation starting from the bottom. Change hands and repeat the operation with the glove opposite the hand.

Spray the pressurized water at each internal surface of the cabin and make sure that any processing residue has been removed.

Spray the pressurized water at each surface of the support bracket of the push-button panel and at the push-button panel itself.

Carefully clean each individual roller conveyor, always making sure that any residue has been removed.

Compliance with this procedure and the use of the product B SANYSAFE C reduces biological risk. If you use different products not indicated, make sure compatibility with the materials present in the system.

NOTICE:

THE INSTRUCTIONS IN THE TABLES OF CHAPTER 4.1 - ROUTINE MAINTENANCE - MUST BE FOLLOWED TO ENSURE CLEANING OF THE SYSTEM IN SAFETY.

3.2.9 MATERIALS COMPATIBLE WITH THE TREATMENT

STAINLESS STEEL	COMPATIBLE
TITANIUM	COMPATIBLE
TUNGSTEN	COMPATIBLE
CERAMICS	COMPATIBLE
GLASS	COMPATIBLE
CANNULATED INSTRUMENTS	COMPATIBLE
MICROSURGERY	COMPATIBLE
RIGID OPTICS	COMPATIBLE only on LENS and STEM
MOTORS	NO DIRECT EXPOSURE ON ELECTRICAL PARTS
ELASTOMERS	NO PROLONGED EXPOSURE
POLYMERS	NO DIRECT EXPOSURE
PAINTED MATERIALS	NOT COMPATIBLE
ALUMINIUM	NOT COMPATIBLE
RESINS	NOT COMPATIBLE
ELECTRICAL WIRES	NOT COMPATIBLE
BATTERY HOLDER	NOT COMPATIBLE

3.3 SWITCHING OFF

IMPORTANT:

IT IS COMPULSORY TO SANITIZE THE INSIDE OF THE CABIN USING THE PROGRAM INDICATED ON THE



PUSH-BUTTON PANEL WITH THE SYMBOL

AND ON THE HMI PANEL BEFORE TURNING OFF

THE DEVICE.

SWITCHING OFF

- It is mandatory to turn off the main switch of the **SAFE CleanBox** by moving it to the horizontal **0-OFF** position.

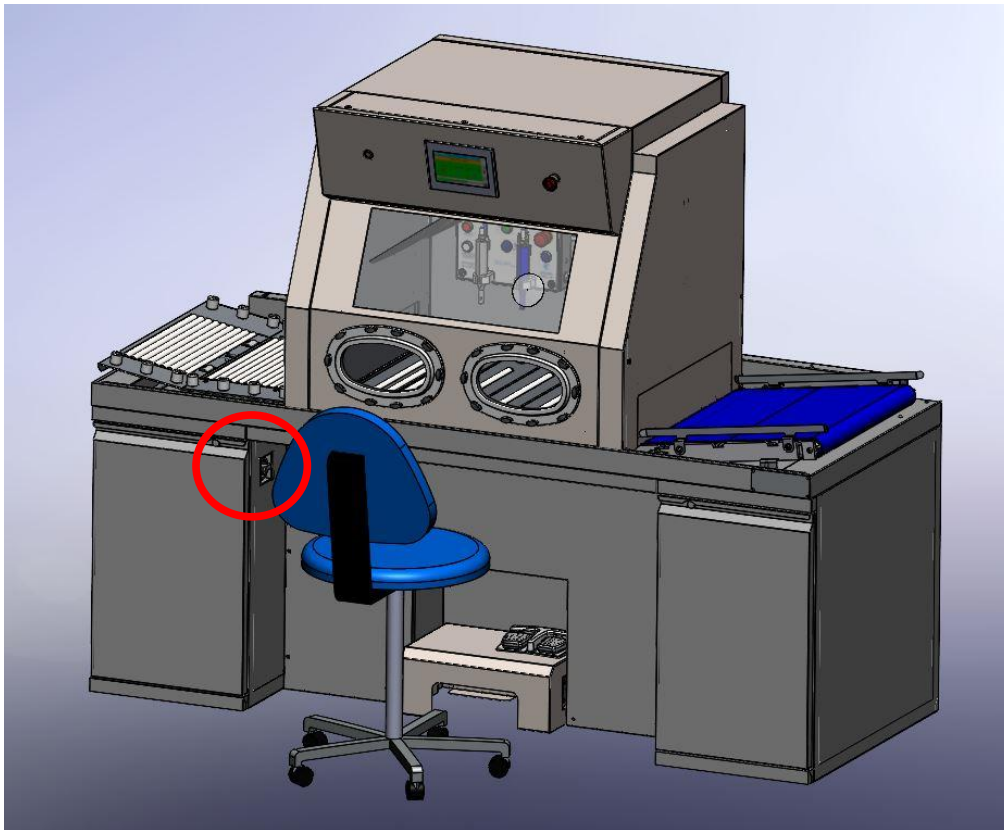

EMERGENCY STOP

- Each operation can be stopped by pressing one of the two emergency buttons on the **SAFE CleanBox**.

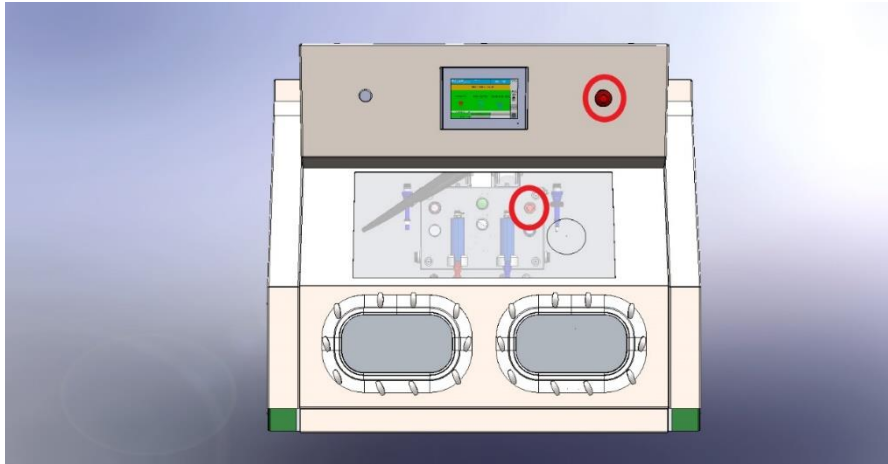

Fig. Mushroom-head emergency stop buttons

The device can be stopped in an emergency by pressing any of the red "Emergency" mushroom-head buttons, of which there is one on the front of the cabin and a second one inside the cabin on the control panel, in order to instantly stop all moving parts and cut off the electrical supply to the panel.

STANDBY

- The standby function is activated automatically after X minutes or by pressing the dedicated button. The machine will turn off the lights and the aspirator but will always be ready for use whenever an operator presses a button or pedal.

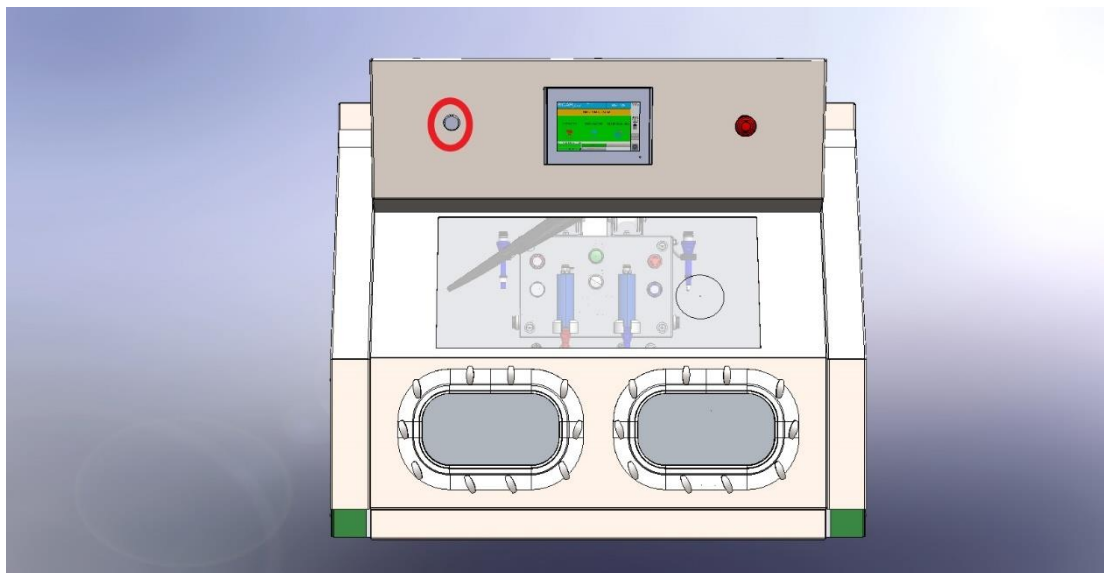

Fig. Standby button

3.4 NOTIFICATIONS / ALARMS

ALARM MESSAGES		
No. - MESSAGE	TYPE OF DISENGAGEMENT	TYPE OF ALARM
01-EMERGENCY ON	RESET	MAJOR
02-DOORS OPEN	RESET	MAJOR
03-DRAIN WATER PUMP THERMAL	RESET	MAJOR
04-INSUFFICIENT AIR PRESSURE	RESET	MAJOR
05-INSUFFICIENT WATER	RESET	MAJOR
06-BICARBONATE CARTRIDGE NOT LOADED	RESET	MAJOR - MINOR
07-LOW BICARBONATE LEVEL	AUTORESET	MINOR
08-INSUFFICIENT BICARBONATE LEVEL	RESET	MAJOR
09-INCONSISTENT BICARBONATE LEVEL	RESET	MAJOR
10-RFID BOTTLE CODE NOT RECOGNIZED	RESET	MAJOR
11-ASPIRATOR THERMAL	RESET	MAJOR
12-		
13-MAXIMUM LEVEL OF DRAIN WATER	AUTORESET	MAJOR - MINOR
14-WEIGHING DEVICE ERROR	RESET	MAJOR
15-RFID TAG READER ERROR	RESET	MAJOR
16-INSUFFICIENT SANITIZING LEVEL	RESET	LOCKING ONLY OF SANITIZATION CYCLE
17-INSUFFICIENT SANITIZING FLOW	RESET	LOCKING ONLY OF SANITIZATION CYCLE
18-WATER LEVEL SENSOR	RESET	MAJOR
19-WATER DRAINAGE	AUTORESET	MINOR
20-LOW SANITIZATION WATER FLOW	RESET	LOCKING ONLY OF SANITIZATION CYCLE
21-ALARM SANITIZING PUMP	RESET	DOES NOT START ONLY THE SANITIZATION CYCLE
22-COMMUNICATION WITH WEIGHING DEV.	AUTORESET	MINOR
23-COMMUNICATION WITH RFID TAG READER	RESET	MAJOR
24-WEIGHING CELL ERROR	RESET	MAJOR
25-		
26-MAXIMUM TIME FOR FILLING THE BIN	RESET	MAJOR
27-INSUFFICIENT SANITATION FLOW	RESET	MAJOR

28-		
29-	RESET	MAJOR
30-	RESET	MAJOR
31- CABIN DOOR CLOSING WITH FT OVERALL DOOR BUSY	RESET	MAJOR
32-	RESET	MAJOR
33-	RESET	MAJOR
34-	RESET	MAJOR
35-	RESET	MINOR
36-	RESET	MAJOR
37-		
38-	RESET	MAJOR
39-	RESET	MAJOR
40-	RESET	MINOR
41-	RESET	MAJOR
42-		
43-		
44-	AUTORESET	MINOR
45-	AUTORESET	MINOR
46-		
47-	AUTORESET	MINOR
48-	AUTORESET	MINOR
49-	AUTORESET	MINOR
50-CABIN LEFT DOOR NOT CLOSED	RESET	MINOR
51-CABIN RIGHT DOOR NOT CLOSED	RESET	MINOR
52-	RESET	MINOR
53-	RESET	MINOR
54-	AUTORESET	MINOR
55-OPENING-CLOSING DOOR TIMEOUT	RESET	MAJOR
56-OPERATOR RFID ERROR	RESET	MAJOR
57-BOTTLE RFID ERROR	RESET	MAJOR
58-DOOR EDGE PRESSED LOAD	RESET	MINOR
59-DOOR EDGE PRESSED UNLOAD	RESET	MINOR

60-BICARBONATE BLOCKED	RESET	MAJOR
61-MEDIUM LOW BICARBONATE FLOW	RESET	MINOR
62-LOG CREATION ERROR	RESET	MAJOR
63-LOG WRITING ERROR	RESET	MAJOR
64-LOG OPENING ERROR	RESET	MAJOR
65-USER NOT RECOGNIZED	RESET	MAJOR
66-CUMULATIVE ROLLER CONVEYOR MOTOR ERROR	RESET	MAJOR

3.4.1 ALARM GUIDE

01-EMERGENCY ON	Reset the emergency button by turning it and reset any messages.
02-DOORS OPEN	Repeat closing of the doors using the buttons inside the cabin.
03-DRAIN WATER PUMP THERMAL	Contact assistance
04-INSUFFICIENT AIR PRESSURE	Insufficient air supply - reset
05-INSUFFICIENT WATER	Insufficient water supply - reset
06-BICARBONATE CARTRIDGE NOT LOADED	The bottle reading sensor does not detect the cartridge. Make sure that the position of the bottle is correct and that there is the orange light on the sensor. If the problem persists, replace the bottle and Reset
07-LOW BICARBONATE LEVEL	Indicates that the bicarbonate is down to the reserve level and the bottle will need to be replaced soon
08-INSUFFICIENT BICARBONATE LEVEL	The bicarbonate has run out. Replace the bottle
09-INCONSISTENT BICARBONATE LEVEL	The bicarbonate bottle has been tampered with, replace it.
10-RFID BOTTLE CODE NOT RECOGNIZED	Replace the bottle
11-ASPIRATOR THERMAL	Contact assistance
12-	
13-MAXIMUM LEVEL OF DRAIN WATER	Contact assistance
14-WEIGHING DEVICE ERROR	Reset
15-RFID TAG READER ERROR	Reset
16-INSUFFICIENT SANITIZING LEVEL	The sanitizer has run out. Replace the tank.
17-INSUFFICIENT SANITIZING FLOW	Incorrect amount of sanitizer during the cycle.
18-WATER LEVEL SENSOR	Contact assistance
19-WATER DRAINAGE	The discharge pump is draining the collection bin. autoreset

20-LOW SANITIZATION WATER FLOW	Incorrect amount of water during the cycle.
21-ALARM SANITIZING PUMP	Dosing pump operation error.
22-COMMUNICATION WITH WEIGHING DEV.	autoreset
23-COMMUNICATION WITH RFID TAG READER	Reset
24-WEIGHING CELL ERROR	Reset
25-	
26-MAXIMUM TIME FOR FILLING THE BIN	Reset
27-INSUFFICIENT SANITATION FLOW	Insufficient quantity of sanitizing agent in the cabin. Possible constriction or puncturing of the hose
28-	
29-	
30-	
31- CABIN DOOR CLOSING WITH FT OVERALL DOOR BUSY	Presence of a tray or an obstacle in front of the passage photocell. Remove the obstacle and continue.
32-	
33-	
34-	
35-	
36-	
37-	
38-	
39-	
40-	
41-	
42-	
43-	
44-	
45-	
46-	
47-	
48-	
49-	
50-CABIN LEFT DOOR NOT CLOSED	Close the doors and continue.

51-CABIN RIGHT DOOR NOT CLOSED	Close the doors and continue.
52-	
53-	
54-	
55-OPENING-CLOSING DOOR TIMEOUT	Reset and, if it persists, contact assistance.
56-OPERATOR RFID ERROR	Press reset and try to login again.
57-BOTTLE RFID ERROR	Reset, if the problem persists, replace the bottle or contact assistance
58-DOOR EDGE PRESSED LOAD	Reset if it persists, contact support
59-DOOR EDGE PRESSED UNLOAD	Reset if it persists, contact support
60-BICARBONATE BLOCKED	Follow the instructions in the monthly maintenance schedule then press Reset. If it persists, contact assistance.
61-MEDIUM LOW BICARBONATE FLOW	Reset
62-LOG CREATION ERROR	Memory full
63-LOG WRITING ERROR	Reset if it persists, contact support
64-LOG OPENING ERROR	Reset if it persists, contact support
65-USER NOT RECOGNIZED	Unknown user error
66-CUMULATIVE ROLLER CONVEYOR MOTOR ERROR	Restart the machine and check the wiring and any alarm messages on the control unit.

3.5 REPLACEMENT OF CONSUMABLES

BICARBONATE REPLACEMENT PROCEDURE:

Open right compartment.
 Pull out the bicarbonate bottle drawer.

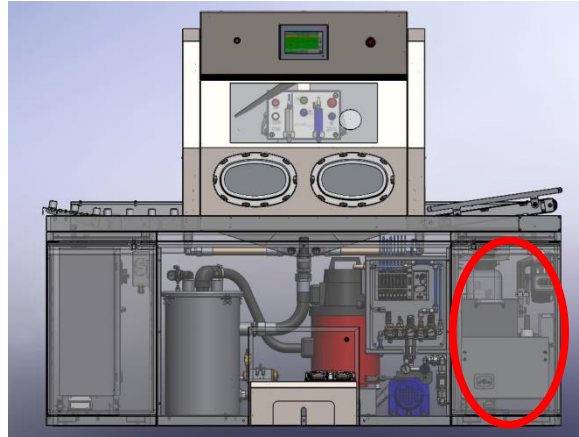

Close the bottle outlet valve (1) by turning it 90 degrees. Then lift the bottle unit by gripping the valve with one hand and the bottle with the other.

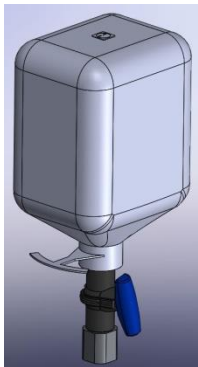

BOTTLE UNIT

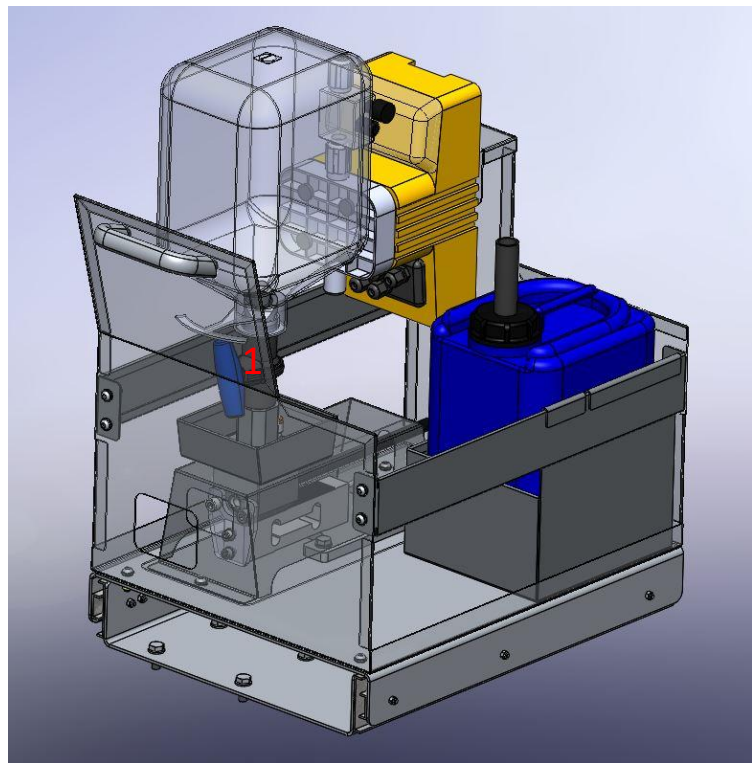

Once extracted, remove the valve unit from the empty bottle and insert it into a new one.

Turn the bottle upside down and place it on its support.

Open the bicarbonate outlet valve by turning it 90 degrees.

Check the correct vertical positioning of the bottle and the presence of the tag on the bottom.

Close the drawer as far as it will go.

Check that the orange light of the reading sensor switches on.

Check that the weight of the new bottle (about 6000 g) has been read correctly in the field at the bottom right on the HMI panel.

Press the left pedal and check that the SAFEKLINIC comes out of the grey handpiece and that there are no alarm messages.

IN CASE OF ANOMALY, REPLACE THE SAFEKLINIC BOTTLE.

SANITIZER REPLACEMENT PROCEDURE:

Open right compartment. Remove the sanitizer tank and the probe inside it, and replace.

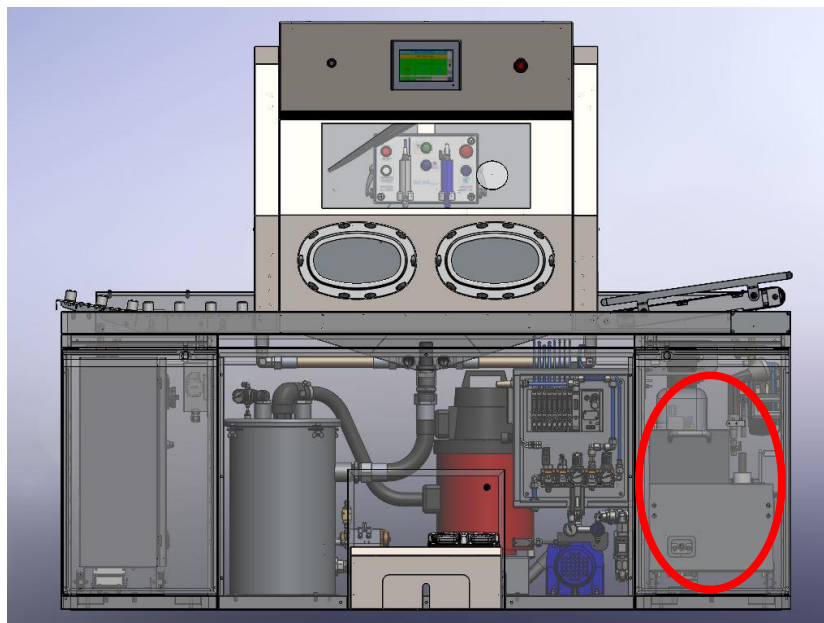
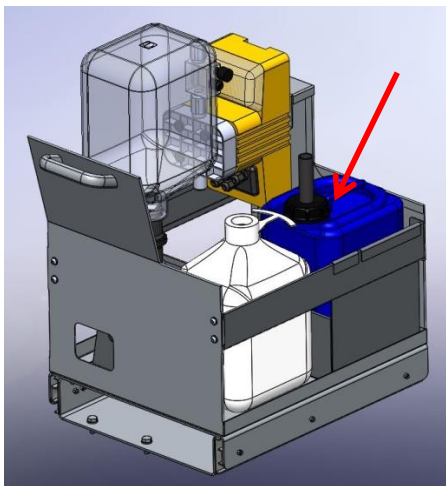

4 MAINTENANCE

The purposes of maintenance are:

- To keep the device in good working order and ensure maximum production at the best quality, minimizing residual risks associated with use of the system;
- to prevent failures and faults and guarantee repairs in the shortest possible time;
- to increase the efficiency of the machines and avoid overly expensive faults and repairs.

The need to carry out this work is established by conducting routine checks and inspections, which simply involve measurements and physical tests to determine the conditions of the machine and main equipment most prone to wear.

The personnel is required to observe the system on the basis of the following sensory principles:

- sight, i.e. optical and visual observation;
- hearing, i.e. listening for noises;
- touch, i.e. sensory detection of temperature, vibrations etc.

These checks, inspections, adjustments or replacements must be carried out at the frequency indicated in the **PREVENTIVE MAINTENANCE SCHEDULE** prepared by the manufacturer.

The work involves routine maintenance as well as non-routine maintenance following faults or breakages.

The management of maintenance has been divided into:

- ROUTINE MAINTENANCE – daily, weekly and monthly
- PREVENTIVE MAINTENANCE - every 4 months
- NON-ROUTINE MAINTENANCE/FAULTS - at the request of the customer or on the manufacturer's recommendation



The useful life of the device if used and maintained properly is 10 years

4.1 ROUTINE MAINTENANCE

ROUTINE MAINTENANCE consists of daily and monthly inspections and checks aimed at obtaining the maximum operating efficiency of the machine.

Routine maintenance is divided into daily and monthly inspections/checks.

Only the prescribed materials (**SAFEKLINIC® and BICARjet® Original Spare Parts**) must be used and routine maintenance must be carried out in a regular and systematic manner in accordance with the indications given in the specific work schedule below.

Trained operators who use the machine and carry out routine daily maintenance must follow the instructions below:

PERSONAL PROTECTIVE EQUIPMENT (PPE):
Nitrile gloves
Protective glasses or face shields
Body gowns or coveralls
Protective footwear

The manufacturer BICARjet S.r.l. is not liable for injury or damage due to non-compliance with this provision. In turn, the employer should evaluate the risks for the operators deriving from the routine maintenance, cleaning and sanitization of the system, in order to define the PPE that it deems most appropriate to carry out these activities and to inform the personnel.

ROUTINE MAINTENANCE: DAILY		
CHECKS AT THE START OF THE WORK SCHEDULE		
DESCRIPTION	WHO	ACTIONS
LEVEL OF SAFEKLINIC® BICARBONATE	TRAINED OPERATOR	Visually check the quantity of SAFEKLINIC® bicarbonate in the bottle located in the lower right compartment. The weight and level of the bottle are indicated on the HMI panel. If necessary, replace the bottle by extracting the whole unit, closing the valve and sliding the bottle upwards. Then insert the valve into the new container, turn the bottle upside down and place it in the appropriate space in the feed unit.
INSIDE LIGHTS	TRAINED OPERATOR	Visually check that the inside lights of the cabin switch on and that the LEDs of the internal push-button panel start flashing (green light, blue light and blue button)
GLOVES AND FLANGES	TRAINED OPERATOR	To avoid unnecessary accidents, it is recommended to visually check the state of wear of the gloves at the beginning of each work cycle, immediately reporting to the internal maintenance manager the presence of any abnormal cuts or abrasions that could affect tactile sensitivity and safe use of the same. It is also important to check closing of the glove flanges on the front of the cabin to avoid leaks.

<p>NOZZLES</p>	<p>TRAINED OPERATOR</p>	<p>Before starting the work schedule, visually check that the spray nozzles are working correctly by checking that the mixture of air, water and SAFEKLINIC® flows freely and continuously from the grey handpiece when the left pedal is pressed and that the air and water mixture flows freely from the blue handpiece when the right pedal is pressed. In relation to the functions described, visually check the operation of the wiper.</p> <p>DO NOT OBSTRUCT OR PLUG THE NOZZLE OUTLET!</p>
<p>SEALS</p>	<p>TRAINED OPERATOR</p>	<p>It is advisable to check visually and by touch (if possible) the air-tightness and wear of the cabin seals. (example: glass panel and doors).</p>

ACTIVITIES AT END OF WORK SCHEDULE		
DESCRIPTION	WHO	ACTIONS
RINSING INSIDE THE CABIN	TRAINED OPERATOR	<p>After using the machine, all processing residues containing SAFEKLINIC® inside the cabin must be rinsed out (with the doors closed) through the blue handpiece. This must be done because the bicarbonate is hygroscopic and highly sensitive to the external environment, and humidity can cause the crystallization of the grains of bicarbonate in the conduits inside the cabin, obstructing them and compromising their durability.</p> <p>Visually check and make sure to also clean the area under the gloves and the entire surface of the ceiling of the cabin with the jet of water.</p>
SANITIZATION OF THE CABIN	TRAINED OPERATOR	<p>SANITIZATION is, to all intents and purposes, a form of maintenance of the machine to minimize as much as possible the risks of proliferation and stagnation of processing residues that could affect the safety of users. For this reason, sanitization is to be considered part of the MANDATORY daily maintenance before shutdown. After rinsing as described above, proceed with sanitization following the instructions in chapter 3.2.</p>
CLEANING, SANITIZATION OF THE EXTERNAL PARTS OF THE CABIN, ROLLER CONVEYOR AND CONVEYOR BELT	TRAINED OPERATOR	<p>STEP 1 – CLEANING THE EXTERNAL PARTS OF THE CABIN, ROLLER CONVEYOR AND CONVEYOR BELT:</p> <p>PROCEDURE:</p> <ol style="list-style-type: none"> Open the doors of the cabin from inside the machine. Remove the hand shower from the compartment on the right of the bench (check the dispensing position, see image) and open the tap below it manually.  <ol style="list-style-type: none"> Use the jet of water to rinse the entire outer edge of the door hinges (detail 1 in the image), removing any contaminants or solid residue. Pay particular attention to the lower edge of the doors, always rinsing it with the hand shower or with a damp cloth.

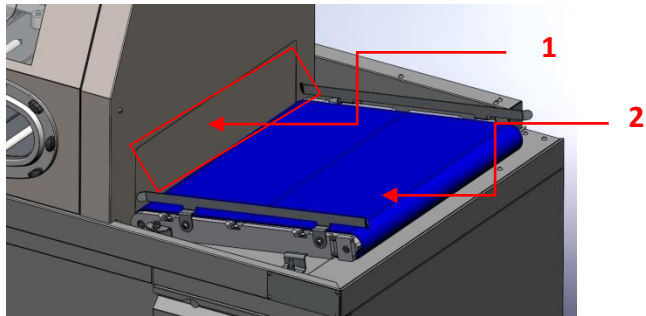

- d) Use the jet of water to rinse the entire outer edge of the door hinges (detail 1 in the image), removing any contaminants or solid residue. Pay particular attention to the lower edge of the doors, always rinsing it with the hand shower or with a damp cloth.

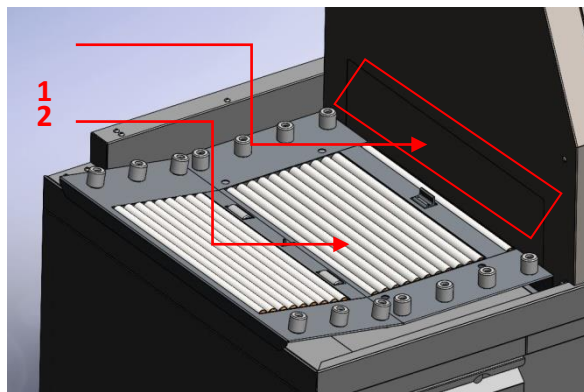

STEP 2 – SANITIZATION OF THE ROLLER CONVEYOR, CONVEYOR BELT AND THE EXTERNAL PARTS OF THE CABIN:

Sanitize by spraying all the surfaces described in points “c” and “d” of the STEP 1 procedure with a disinfectant spray. (follow the manufacturer's instructions) **NB: The rubber conveyor belt is not compatible with acids.**

Do not use a foaming spray.

The use of alcohol based disinfectants/cleaners is recommended.

STEP 3 – CONTACT TIME FOR THE ROLLER CONVEYOR, CONVEYOR BELT AND THE EXTERNAL PARTS OF THE CABIN:

Check the spray contact time according to the instructions for the product used.

STEP 4 – RINSING THE ROLLER CONVEYOR, CONVEYOR BELT AND THE EXTERNAL PARTS OF THE CABIN:

		<p>Once the contact time for the external roller conveyor, the conveyor belt and the outer closing edge of the doors has elapsed, rinse with plenty of water using the hand shower.</p> <p><u>Make sure to close the tap below the hand shower before placing it in the compartment on the right of the bench.</u></p> <p>STEP 5 - DRYING:</p> <p>Wipe the entire surface of the external roller conveyor with paper or a dry cloth to remove any residual water.</p> <p>Repeat the same procedure for the conveyor belt, in particular the entire surface of the belt, the tray guide profiles and the plastic feet and profiles for centring the conveyor belt with the door.</p>
--	--	--

ROUTINE MAINTENANCE: WEEKLY		
ACTIVITIES AT END OF WORK SCHEDULE		
DESCRIPTION	WHO	ACTIONS
CLEANING IN CABIN WITH BICARBONATE	TRAINED OPERATOR	<p>Clean the internal walls of the cabin thoroughly using the bicarbonate handpiece. This will permit complete mechanical removal of all solid residues deposited inside.</p> <p>Visually check that all residues have been removed, using the blue handpiece to rinse thoroughly with pressurized water.</p>
SANITIZATION OF THE CABIN	TRAINED OPERATOR	<p>Proceed with an internal sanitization of the cabin as instructed in chapter 3.2 of the user manual.</p>
SANITIZATION OF THE ROLLER CONVEYORS INSIDE THE CABIN	TRAINED OPERATOR	<p>Remove the roller conveyors in the cabin (7 horizontal roller conveyors) by lifting them upwards. Allow them to soak in a tank containing a solution of water and disinfectant.</p> <p>Wait for the contact time declared by the product.</p> <p>The support roller conveyors outside the cabin can be subjected to a standard thermal disinfection washing cycle.</p> <p>Visually check that the tank under the roller conveyors and the drain are free from any solid residue or otherwise use the blue handpiece to rinse until the material is completely removed. N.B.: Do not remove the filter.</p>
SANITIZATION OF THE GLOVES	TRAINED OPERATOR	<p>Extract the gloves by removing the front flanges and leave them immersed in a tank with a solution of water and disinfectant.</p> <p>Wait for the contact time declared by the product.</p>
CLEANING THE INSIDE OF THE GLASS PANEL	TRAINED OPERATOR	<p>Introduce an anti-limescale spray in the cabin, cover all the glass internally, wait 2 minutes and rinse thoroughly using the blue handpiece.</p>

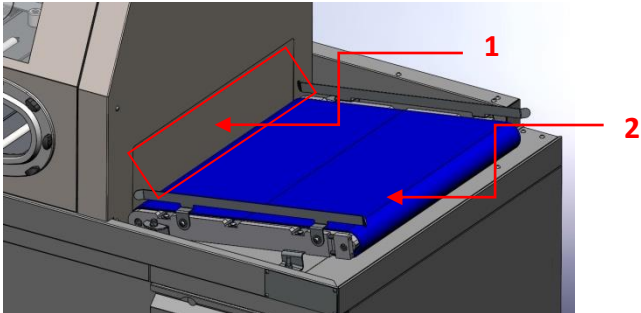
<p style="text-align: center;">SANITIZATION OF THE ROLLER CONVEYOR AND CONVEYOR BELT</p>	<p style="text-align: center;">TRAINED OPERATOR</p>	<p>STEP 1 - CLEANING THE EXTERNAL PARTS OF THE CABIN AND ROLLER CONVEYORS:</p> <p>PROCEDURE:</p> <ol style="list-style-type: none"> a) Open the doors of the cabin from inside the machine. b) Remove the hand shower from the compartment on the right of the bench (check the dispensing position, see image) and open the tap below it manually.  <ol style="list-style-type: none"> c) Use the jet of water to rinse the entire outer edge of the door hinges (detail 1 in the image), removing any contaminants or solid residue. Pay particular attention to the lower edge of the doors, always rinsing it with the hand shower or with a damp cloth. 
---	--	--

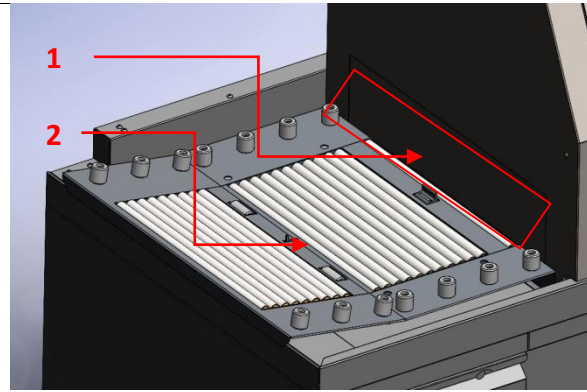

- d) Use the water jet to rinse the external conveyor belt on the right (in particular the entire surface of the belt, the side profiles and the plastic feet and centring profiles) and the external roller conveyor on the left of the cabin. (detail 2 in the image)

STEP 2 – REMOVING THE ROLLER CONVEYOR AND CONVEYOR BELT:

Remove the roller and conveyor belt and place them on a bench where they can be cleaned separately. The conveyor belt is connected to the machine via an electrical cable with a double male-female connector, which can be easily disconnected by unscrewing the ring nut and pulling the connectors in opposite directions.

STEP 3 – SANITIZATION OF THE ROLLER CONVEYOR AND CONVEYOR BELT:

Sanitize by spraying all surfaces of the roller conveyor and conveyor belt with a disinfectant spray. **N.B. The rubber conveyor belt is not compatible with acidic substances.**

Do not use a foaming spray.

The use of alcohol based disinfectants/cleansers is recommended.

STEP 4 – CONTACT TIME FOR THE ROLLER CONVEYOR AND CONVEYOR BELT:

Check the spray contact time according to the instructions for the product used.

STEP 5 – RINSING THE ROLLER CONVEYOR AND CONVEYOR BELT:

		<p>Once the contact time for the external roller conveyor, the conveyor belt and the outer closing edge of the doors has elapsed, rinse with plenty of water using the hand shower.</p> <p><u>Make sure to close the tap below the hand shower before placing it in the compartment on the right of the bench.</u></p> <p>STEP 6 - DRYING:</p> <p>Wipe the entire surface of the external roller conveyor with paper or a dry cloth to remove any residual water.</p> <p>Repeat the same procedure for the surfaces outside the cabin on which the roller conveyor and conveyor belt rest.</p>
--	--	---

ROUTINE MAINTENANCE: MONTHLY

ACTIVITIES AT END OF WORK SCHEDULE

DESCRIPTION	WHO	ACTIONS
CLEANING THE BICARBONATE FEED UNIT	TRAINED OPERATOR	<p>Remove the bottle of SAFEKLINIC, closing the valve manually. Completely remove any excess bicarbonate that has accumulated in the injection port using the suction system. Replace the bottle of SAFEKLINIC with the valve closed.</p> <p>Now run the automatic cleaning cycle for the bicarbonate feed unit using the “UNBLOCK BICARBONATE” function on the settings/menu screen.</p> <p>Once the cycle has been completed, open the valve of the SAFEKLINIC bottle. Press the spray pedal and make sure that the weight of bicarbonate decreases.</p>
BIN CLEANING CYCLE	TRAINED OPERATOR	<p>Press settings on the HMI touch panel and then press the BIN CLEANING CYCLE button.</p> <p>The button will become blue (in operation) and will activate a cycle in which water jets will automatically clean the inside of the collection bin and then discharge the contents via the pump. All operations are repeated twice.</p> <p>The duration of the cycle varies from 3 to 5 minutes.</p>

IMPORTANT:

*Any damage due to wear, breakages or malfunctions encountered during the inspections/checks described above must be reported to the department manager and to the manufacturer (BICARjet S.r.l.). The customer, and therefore the trained operators who use the **SAFE CleanBox** machine, are only authorized to replace the gloves.*

4.2 PREVENTIVE MAINTENANCE

PREVENTIVE MAINTENANCE means all the maintenance operations of inspection/control, adjustment and replacement of parts aimed at preventing fault, according to established criteria.

To be carried out by:

BICARjet® S.r.l. technician qualified technician provided by **BICARjet® S.r.l.** or specialized personnel trained by **BICARjet® S.r.l.** to carry out replacements / repairs and operational checks.

Frequency:

every four months.

An indicator light on the HMI touch panel of the SAFE CleanBox devices indicates if scheduled preventive maintenance has to be carried out:

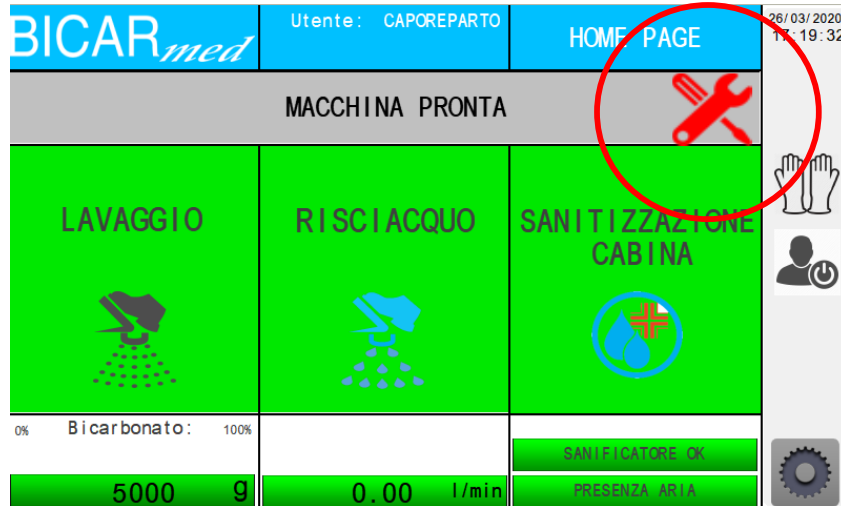

PRE-MAINTENANCE ACTIVITIES

SYSTEM STATUS/CONDITION

CHECKS TO CARRY OUT ON MODEL STK 110 (indicate N/A where the check cannot be carried out)				
No.	PRE-MAINTENANCE ACTIVITIES	RESULT		
		Pos	Neg	N/A
1	Visual inspection to assess the integrity and stability of the system			
2	Sanitization of the inside of the cabin			
3	Sanitization of the outside of the cabin			
4	Sanitization of the mats inside the cabin and the gloves			
5	Sanitize the tray infeed roller conveyor and outfeed conveyor belt.			
No.	OPERATIONS	RESULT		
		Pos	Neg	N/A

1	General cleaning of the system			
2	Check the integrity and operation of the safety devices			
3	Check the integrity of the glass panels on the top of the cabin and the air-tightness of their seals			
4	Check the integrity and operation of the LED lamps			
5	Check the integrity and operation of the doors and the tightness of their seals			
6	Check the integrity and the seal of the glove flanges and gloves			
7	Check the integrity of the internal push-button panel and the operation of the buttons			
8	Check the integrity of the hoses inside the cabin			
9	Check the integrity of the pedals, their connector and the operation of the handpieces inside the cabin			
10	Check the operation of the external touch panel			
11	Removal of the front guard of the bench			
12	Check the integrity and operation of the aspirator			
13	Check the integrity of the air/water/drain hoses			
14	Check the integrity of the air pressure gauges and the reading of the water flow switch			
15	Check the integrity of the collection bin under the bench			
16	Opening of the collection bin, sanitization of the lid and bin			
17	Cleaning of the bicarbonate compartment under the bench on the right side			
18	Check the integrity and operation of the bicarbonate feed unit			
19	Check the integrity and operation of the conveyor belt			

MAINTENANCE REPORT	
SYSTEM STATUS/CONDITION	

4.3 NON-ROUTINE MAINTENANCE AND REPAIRS

NON-ROUTINE MAINTENANCE AND REPAIRS means all diagnostics, replacement and adjustment of parts, aimed at repairing a fault or resolving anomalies, according to established criteria.

To be carried out by:

BICARjet® S.r.l. technician qualified technician provided by **BICARjet® S.r.l.** or specialized personnel trained by **BICARjet® S.r.l.** to carry out replacements / repairs and operational checks.

DIAGNOSTICS AND TROUBLESHOOTING:

- **The device does not start:**
 Check that the emergency mushroom-shaped buttons on the cabin are not pressed, and if necessary release the buttons by turning them anticlockwise and repeating the start-up procedure.

- **Air or water alarm:**
 Check the pressure and flow rate of the compressed air and/or water supply, which is too low. Check that the supply valve is completely open and check the inlet piping for any bottlenecks.

- **The electrical equipment does not work:**
 Check the electrical connection and, if the problem is not solved, check the fuses located inside the electrical panel.

- **Generic alarm does not reset:**
 first activate the emergency buttons and then rearm them, reset everything and see if the problem has been resolved, or turn the system off and on again.

- **Bicarbonate blocked or inconsistent:**
 follow the monthly maintenance procedure to unblock the bicarbonate, if blocked.
 If inconsistent, replace the bottle.

- **When operating the wiper, the blade does not move:**
 Check that the fixing screw of the arm has not come loose. If necessary, re-tighten the screw and make sure it is symmetrical in relation to the axis of the wiper itself.

4.4 POST-MAINTENANCE CHECKS

No.	PRELIMINARY CHECKS	RESULT		
		POSITIVE	NEGATIVE	N/A
	before supplying electrical power to the system, check:			
1	the integrity and stability of the system			
2	the integrity of the electrical, compressed air, water and drain connections			
3	the mains air and water wall valves do not leak			
4	the safety systems are intact and have not been triggered			
5	the integrity of the hoses inside the cabin			
6	the integrity of the conveyor belt's electrical connection			

No.	OPERATION CHECKS	RESULT		
		POSITIVE	NEGATIVE	N/A
	supply electrical power to the system and check:			
1	switching on of the touch panel and loading of the program			
2	switching on of the lights inside the cabin			
3	switching on of the indicator lights of the push-button panel inside the cabin			
4	the absence of alarms/signals at the panel			
5	the presence of air/water at the panel			

6	operation of the emergency buttons			
7	operation of the sensitive edges of the doors			
8	Operation of the conveyor belt			
9	operation of the doors			
10	loading the SAFEKLINIC bottle			
11	loading the SANITIZER bottle			
12	operation of spray handpieces by pressing the pedals			
13	operation of the wiper/water by pressing the pedals			

4.5 TECHNICAL ASSISTANCE

BICARjet S.r.l.

Registered office - Via Nona Strada, 4 - 35129 Padova, Italy

Tel. 049 7808036 / fax. 049 7927203

info@bicarmed.com

4.6 WARRANTY TERMS AND CONDITIONS

The terms and conditions of the warranty are:

- validity for 12 months from the date of testing and commissioning of the machine

(materials recognized by the manufacturer as defective, excluding consumables and normal wear and tear)

5 CLEANING

In addition to cleaning the interior of the cabin, which should always be carried out after use of the device according to the instructions given previously, it is also important to keep the external surfaces of the device clean.

Clean the casing of the device, the panels and the controls with soft cloths that are dry or that have been dampened with a mild detergent solution. **Do not use any type of solvent, such as alcohol or petrol, as they may damage the surfaces. Do not use substances that are abrasive or corrosive or contain chlorine.** This operation must be done at least once a week.

It is possible to rinse the outer surfaces of the machine, the external roller conveyor and the conveyor belt with the hand shower located in the bottom right corner of the compartment. (see image below)

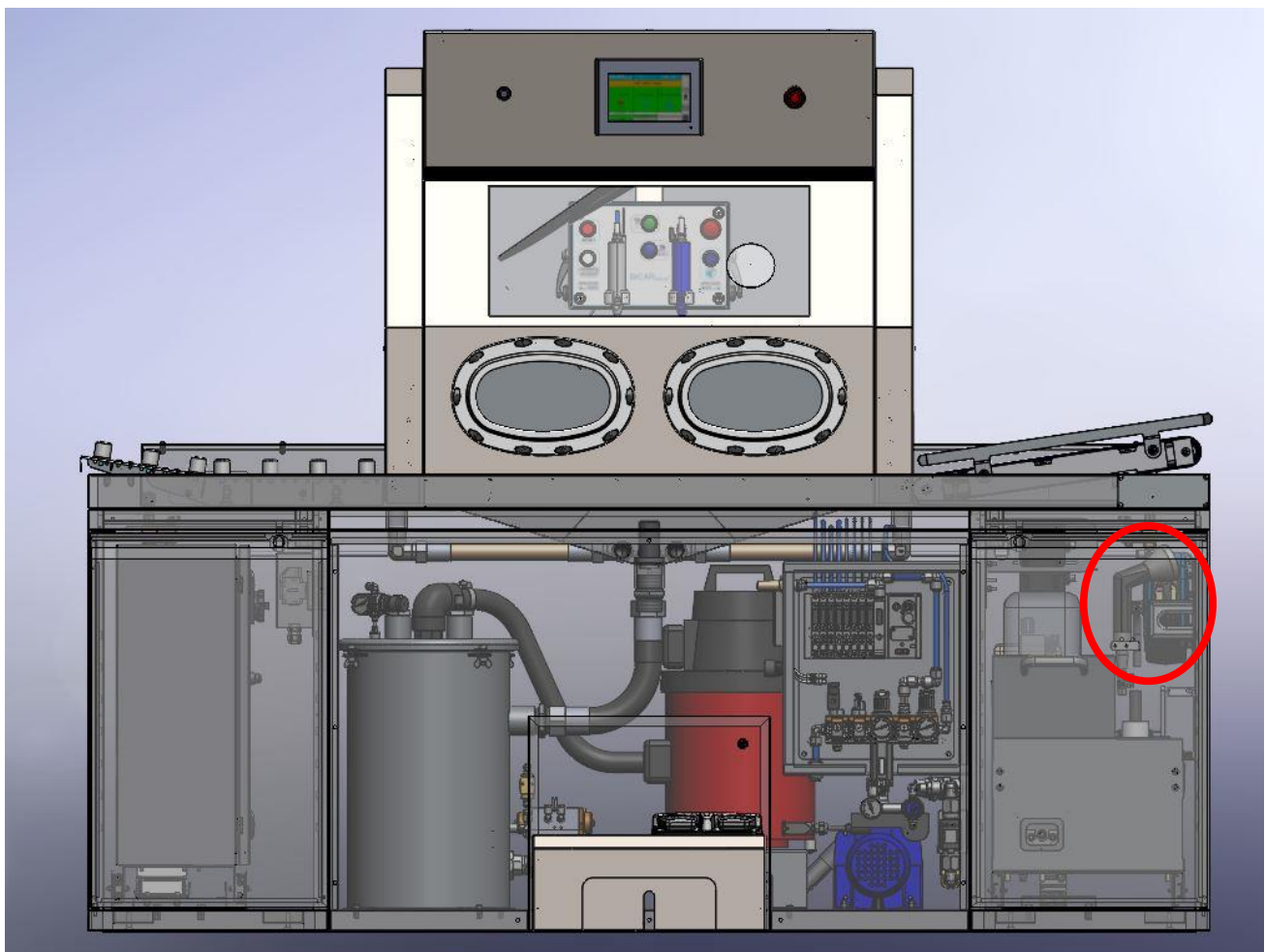

NOTICE:

DO NOT USE WATER OR LIQUIDS FOR CLEANING THE SAFEKLINIC COMPARTMENT. THE INSTRUCTIONS IN THE TABLES OF CHAPTER 3 - ROUTINE MAINTENANCE - MUST BE FOLLOWED TO ENSURE CLEANING OF THE SYSTEM IN SAFETY.

6 DISPOSAL



Do not dispose of this product and its accessories as unseparated waste. Prepare the product for recycling or separate collection in accordance with Italian Legislative Decree no. 49 of 14 March 2014 entitled "Implementation of Directive 2012/19/EU, on waste electrical and electronic equipment (WEEE)".

When used in hospitals, follow their internal rules for the disposal of electrical and electronic waste.









7 TECHNICAL FEATURES

Model	SAFE CLEAN BOX
Code	STK110
Dimensions	2100 mm (w) x 834 mm (d) x 1705 mm (h)
Weight	550 kg
Power supply	220 V - 50 Hz - 16 A
Power consumption	3.2 kW

Environmental conditions	Temperature:	Use	+5 / +40°C
		Storage / transport	-20 / +70°C
	Humidity:	Use	20 / 80% Rh non-condensing
		Storage / transport	5 / 95% Rh non-condensing
	Atmospheric pressure:	Use	800 hPa
		Storage / transport	500 to 800 hPa (375 - 600 mm Hg)

8 LABELLING

8.1 RATING PLATE INFORMATION

 Tel. +39 0497808036 E-mail: info@bicarjet.com		 BICARjet S.r.l. Via Nona Strada, 4 – 35129 Padova, Italia
SAFE CLEANBOX		
REF	[codice del prodotto]	
SN	[numero di serie]	
[UDI]		
		230 V, 50 Hz, xxx KW
 IT AAAA/MM/GG o AAAA/MM	 5°C – 40°C	
		

8.2 INTERNAL MARKINGS

All protective earth terminals have this marking.



8.3 WATER SUPPLY, COMPRESSED AIR AND DRAINAGE

The following marking will be located near the connection between the hydraulic circuits of the device and structure.

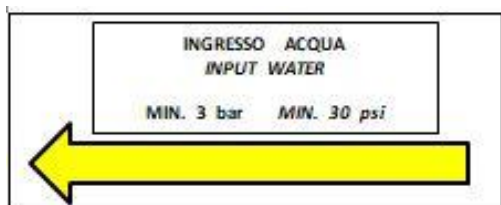

The following marking will be located near the connection between the compressed air circuit of the device and the distribution network of the structure.

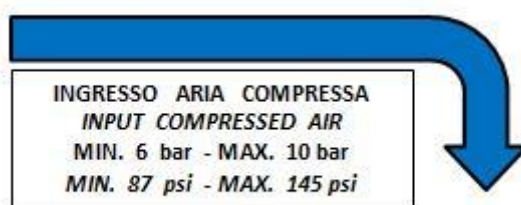

The following marking will be located near the connection with the liquid drain.



















8.4 WARNING MARKINGS

The following markings are located on the door of the electrical panel.



8.5 SAFETY SYMBOLS AND LABELLING

	Manufacturer identification
REF	Product identification code
SN	Production serial number

 YYYY/MM/DD or YYYY/MM	Country of manufacture and date of manufacture.
	Medical device
	Alternating current
	Earth terminal
	Dispose of according to WEEE regulations
	Consult the user manual
	Complies with Regulation (EU) 2017/745, MD class I
	Danger of: xxx (generic symbol to be associated with descriptions)
	Danger due to the presence of live parts
	Hand crushing hazard
	Direction and characteristics of flow
	Direction of the discharge flow with the presence of potentially bio-contaminating residues
	Do not use water for washing/cleaning
	Sanitizer tank compartment
	SAFEKLINIC® bottle compartment
	Ambient operating temperature

9 ELECTROMAGNETIC COMPATIBILITY

9.1 EMC WARNINGS

The appliance complies with the collateral standard EN 61326-1 applicable to the product and relating to electromagnetic compatibility.



THE APPLIANCE MUST BE INSTALLED AND COMMISSIONED ACCORDING TO THE EMC INFORMATION PROVIDED IN THIS SECTION.



THE EQUIPMENT MAY BE AFFECTED BY COMMUNICATION EQUIPMENT AND MOBILE PHONES.



THE EQUIPMENT MUST ONLY BE USED WITH THE CABLES SPECIFIED BY THE MANUFACTURER.



THE DEVICE MUST NOT BE USED NEAR OR IN COMBINATION WITH OTHER EQUIPMENT IN ORDER TO AVOID INTERFERENCE DURING NORMAL USE.

The device falls into group 1 and class A, according to the definitions of the EN 55011 standard, as follows:

- Group 1: Group 1 includes all equipment covered by the EN 55011 standard which does not fall within the definition of group 2 equipment.
- Class A: equipment suitable for use in all places other than those in residential environments and those directly connected to a low voltage power supply network for buildings put to domestic uses.

10 TUTORIAL ON CORRECT CLEANING OF THE INSTRUMENTS

The following tutorials are application examples of BICARmed technology.

10.1 DRILL TUTORIAL



Pay attention to the electrical connections, do not use the bicarbonate jet, rinse only.



Clean inside and attempt flushing. Refer to the procedure for cannulated instruments described in Tutorial 4.

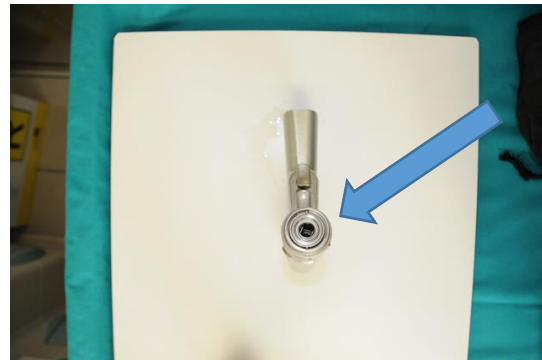

Clean inside and attempt flushing.

N.B. Rinse thoroughly. Once removed from the cabin, it is important to decontaminate.

10.2 SHIELDED CABLE - 296-4 05168



Only the steel ends can be treated, not the plastic hose.

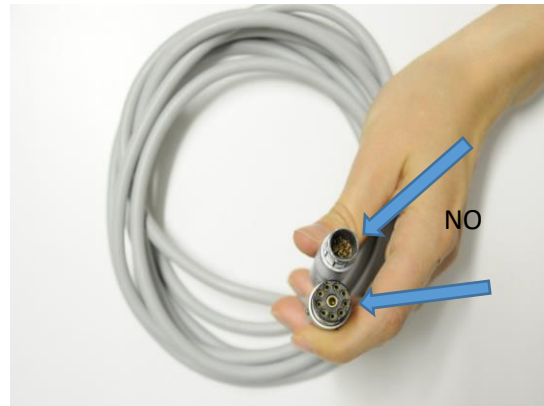

Be careful not to treat the electrical connections. Rinse thoroughly.

10.3 SHIRT FOR LAPAROSCOPIC (CANNULATED) INSTRUMENTS

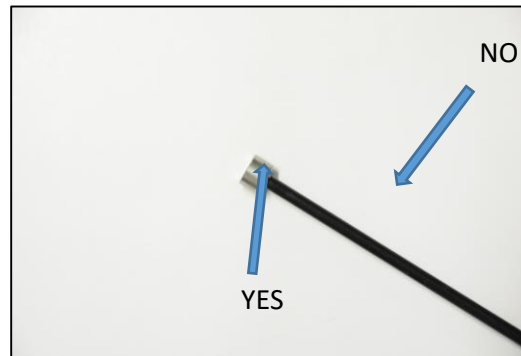
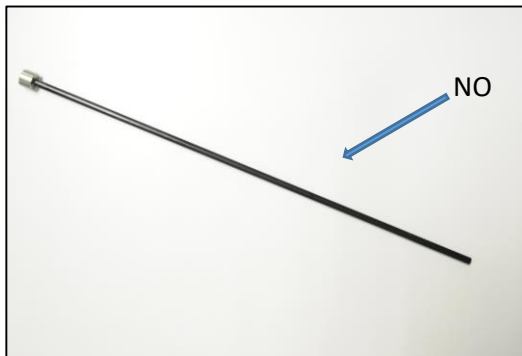

Treat the metal end. Do not treat the polymer body.

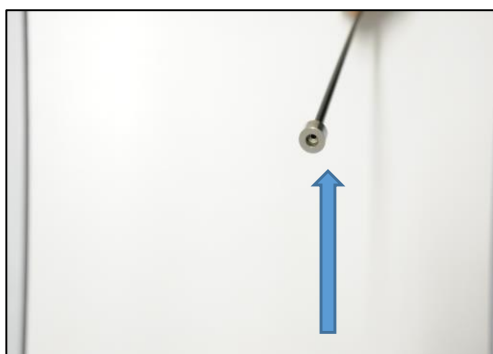

YES

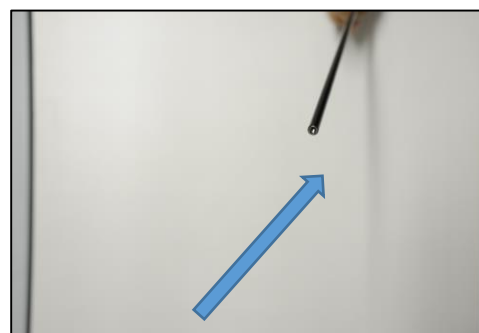

See procedure below.

10.4 PROCEDURE FOR CANNULATED INSTRUMENTS

To clean the cannulated instruments, flush water with the supplied gun to check the state of patency upon receipt (**figure 1**), repeat this operation until a minimum flush is visible

Then position the object with the inlet hole perfectly aligned with the hole in the spray nozzle at a distance of about 12-18 cm in order to facilitate entry of the product into the cannulated instrument (**figure 2**). Spray for 5-10 seconds and/or until visible filling of the product (**figure 3**), then flush the product with the water gun (**figure 1**).

In case of visible residues from the hole(s) of the outlet repeat the entire operation.



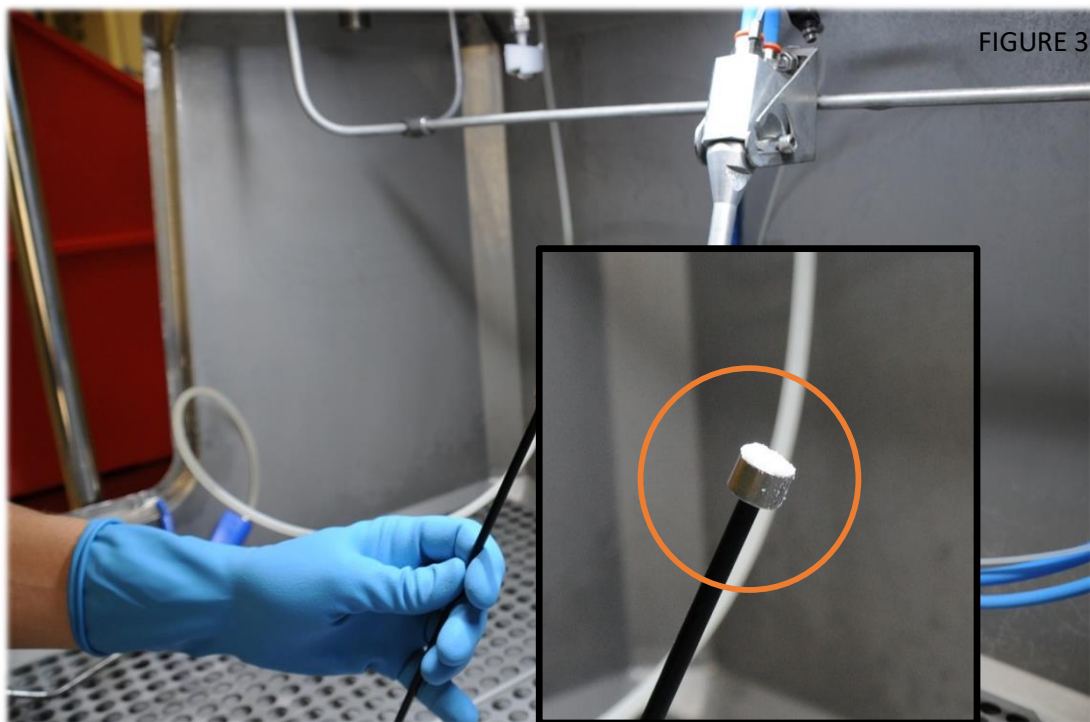

10.5 MONOPOLAR INSULATED FORCEPS

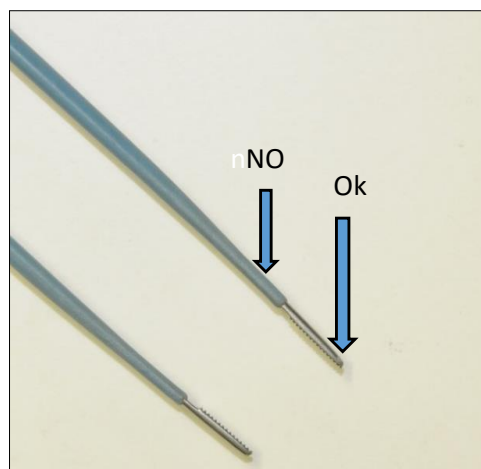
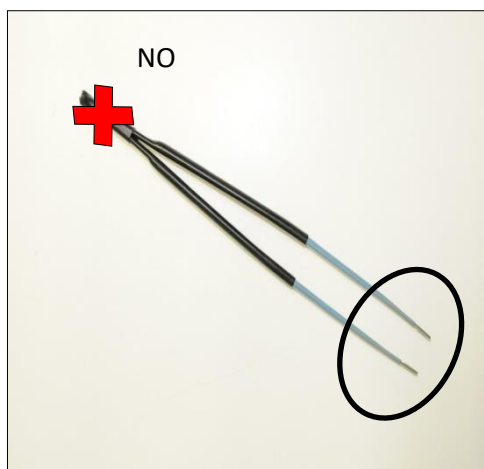

Clean the metal tips thoroughly. Do not treat the polymer handles, and do not flush the attachment point of the forceps marked with the red X in the image.

10.6 VICKERS ELEVATOR - KLS MARTIN 23-506-17



Steel instrument with titanium handle. Treat every point carefully, especially the knurls.

10.7 BONE FORCEPS - SYNTHES 398.81

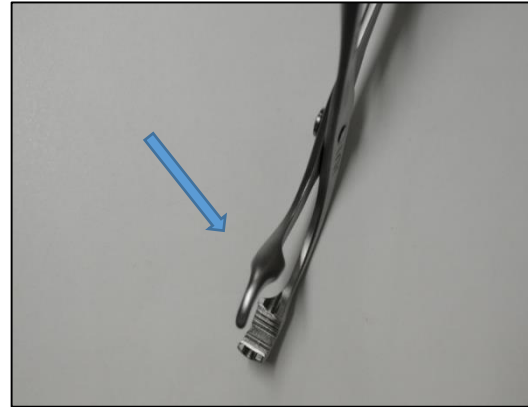
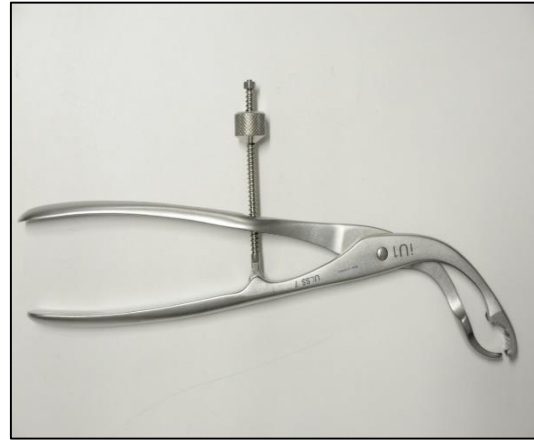
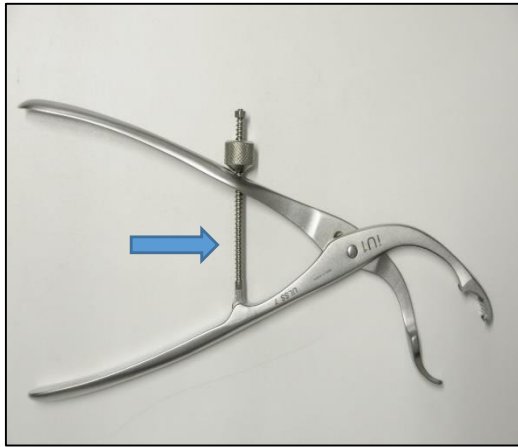

Steel instrument. Treat the entire surface, slide the bolt on the screw for ease of cleaning, focus on the knurls

10.8 BIPOLAR FORCEPS - SOFAR 82410001 / BISSINGER 82410034

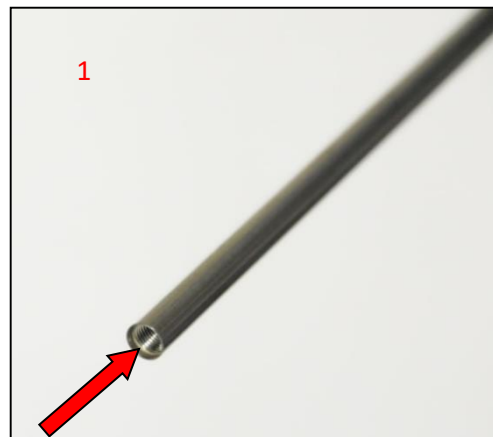
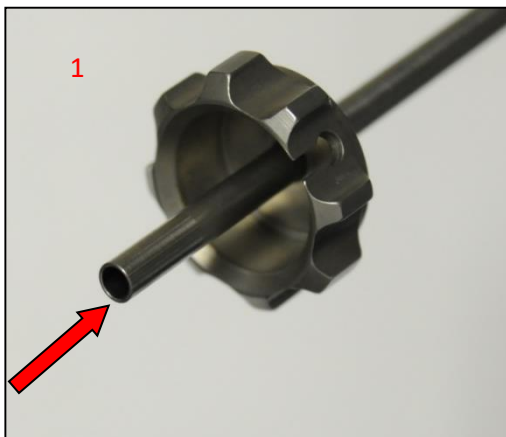

Clean inside with care and attempt flushing. Refer to the procedure for cleaning cannulated instruments described in Tutorial 4

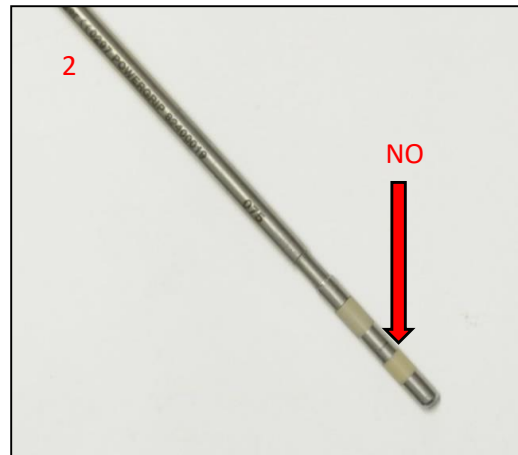
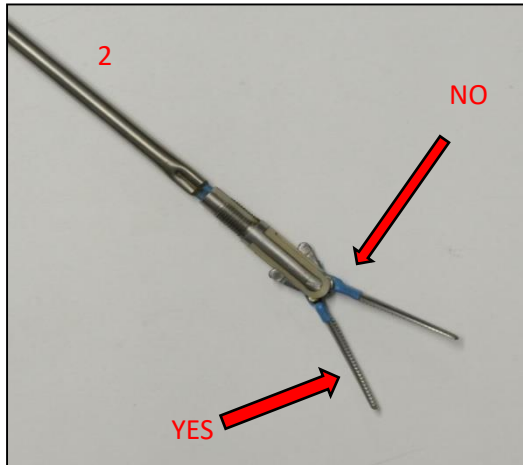

Pay attention to the plastic parts and do not treat with the jet. Treat the extremities with the utmost care.



Do not treat these directly with the jet.

Rinse thoroughly.

10.9 TEMPORARY COVER - STORZ 27 026 UO

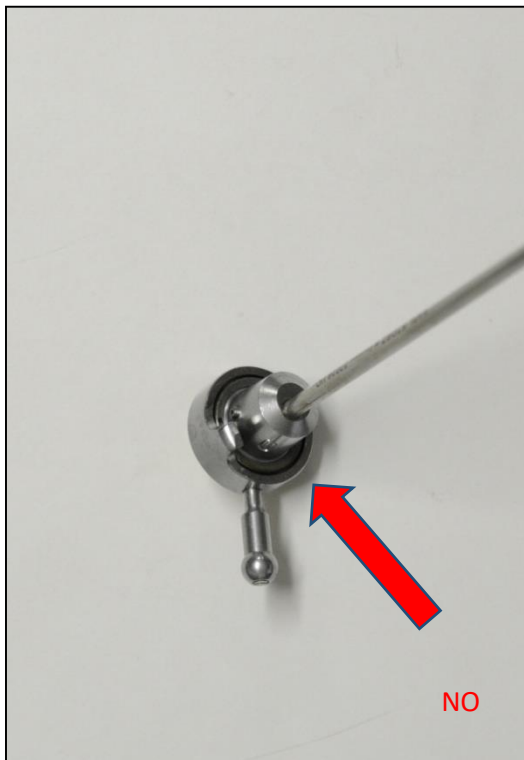

Clean with care the more complex parts where there may be residues. Do not treat the plastic part with the jet

10.10 MONOPOLAR HOOK FOR COAGULATION



Be careful not to treat the inside of the compartment with the jet (because it is made of plastic), but only rinse thoroughly

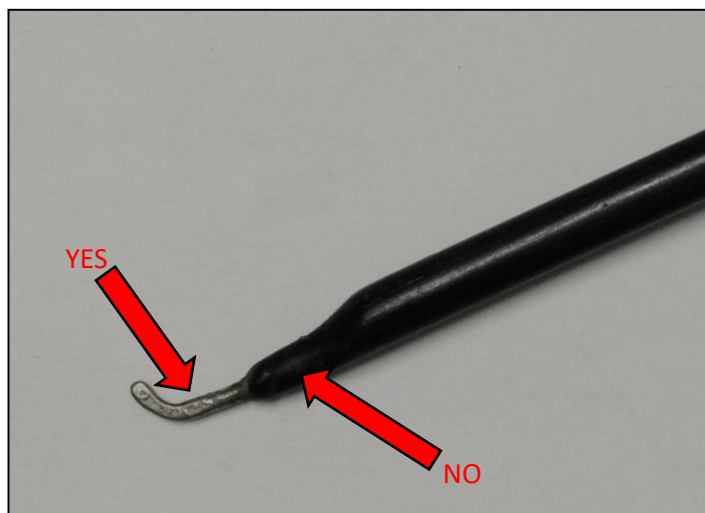

10.11 BIPOLAR FORCEPS - MICRO FRANCE CEV 136

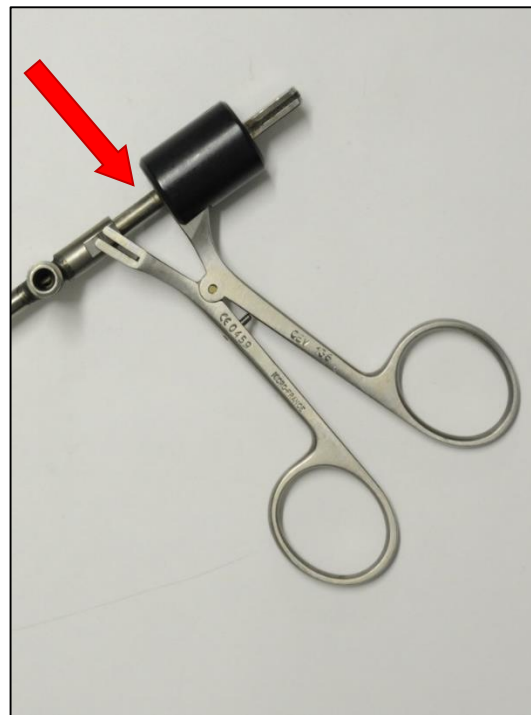

Slide the mechanism in order to also remove any residues inside.

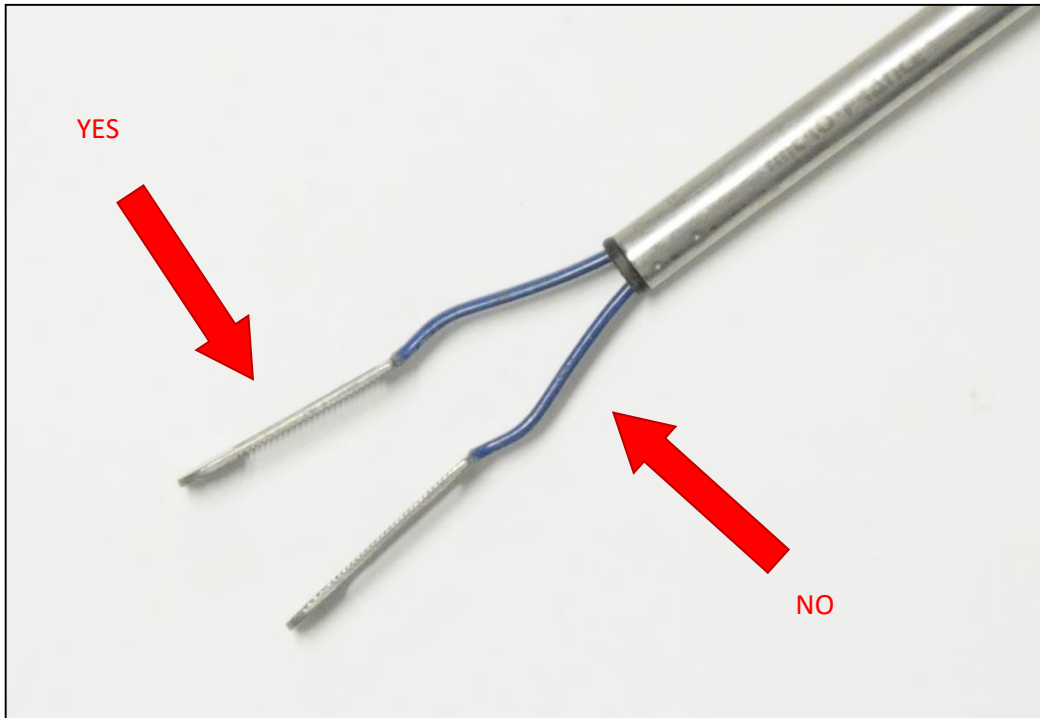

Do not treat the plastic parts with the jet.

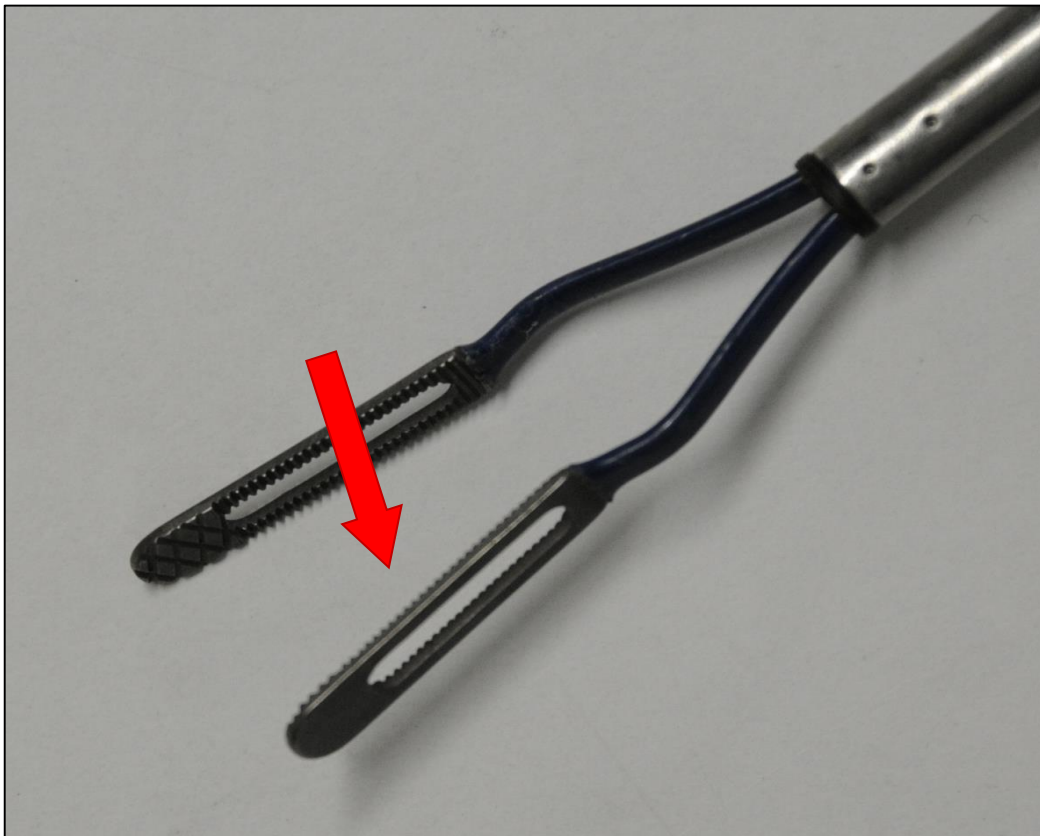

Treat the knurls on the ends carefully.

10.12 MONOPOLAR FORCEPS - REMA 28 - 247 - 000

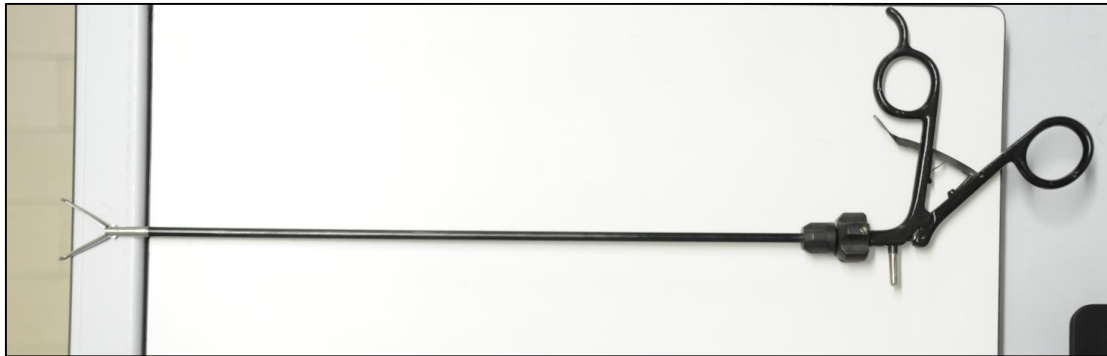

Do not treat the plastic body with the jet. Disassemble the various parts in order to treat the metal points and rinse the plastic parts with water.

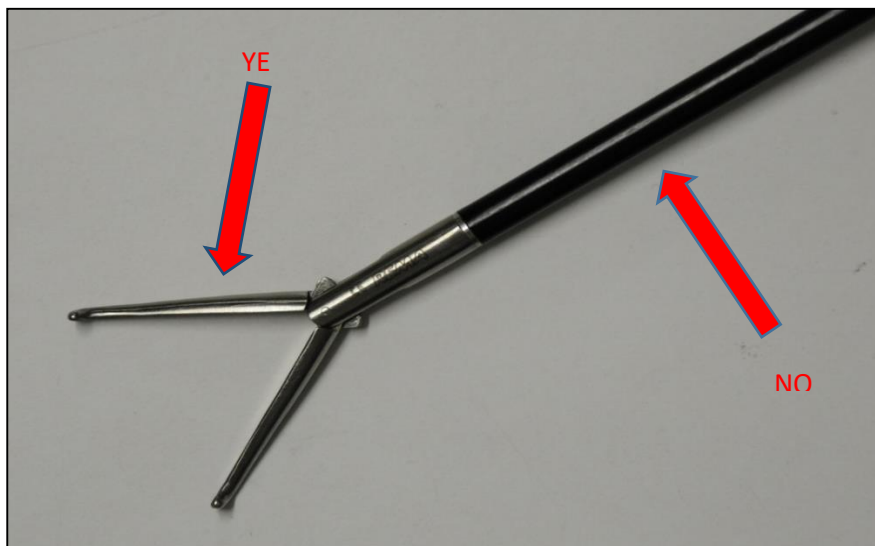

Be careful not to treat the plastic parts; clean only the metal tip with the jet.

10.13 CYSTOSCOPY SHIRT - STORZ 27 026 B



10.14 OBJECT ENTIRELY IN METAL. TREAT WITH THE JET IN FULL.

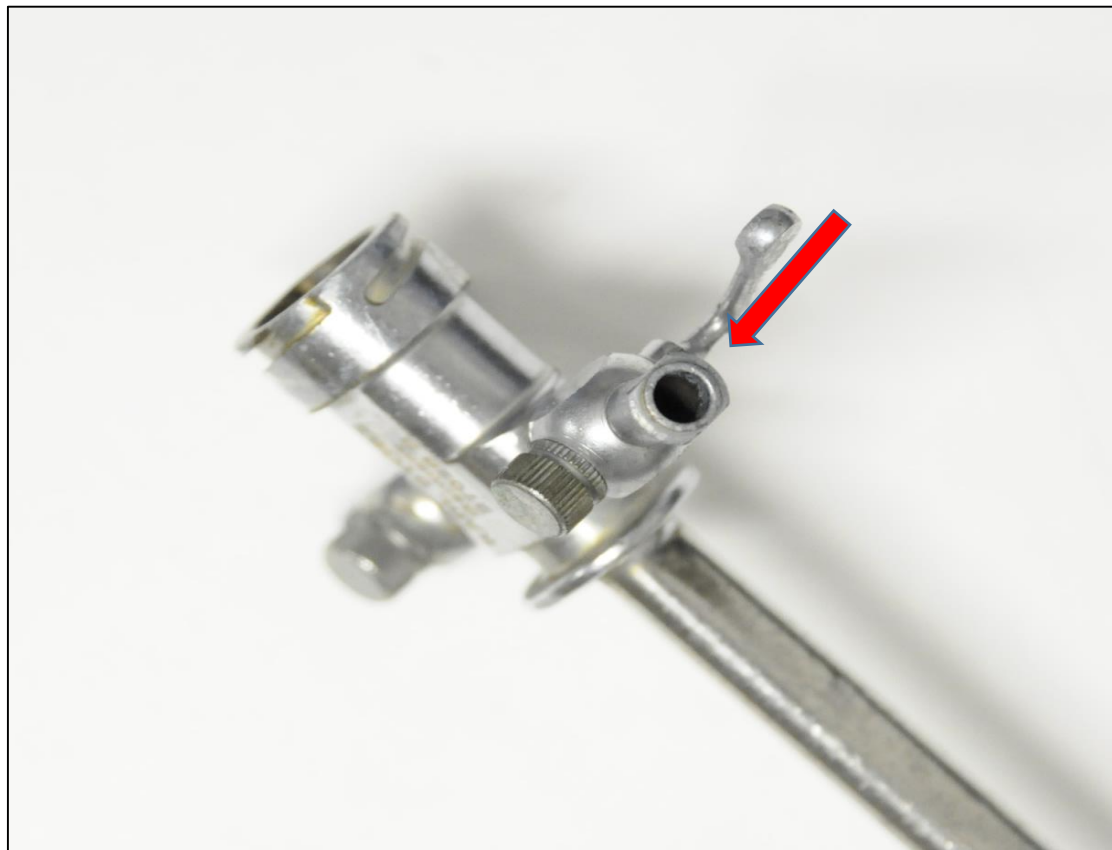

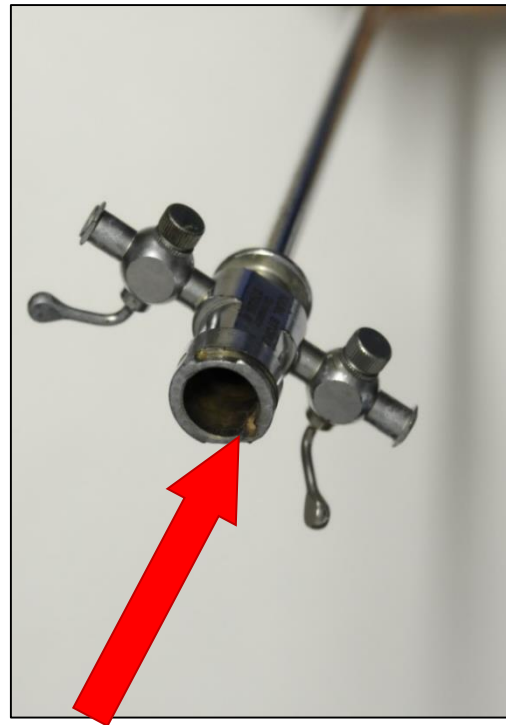

Carefully clean all the critical points of the object. Clean the inside of the cannulated instrument and attempt flushing. Follow the procedure described in tutorial 4.

10.15 OBJECT X - MITEK 214615

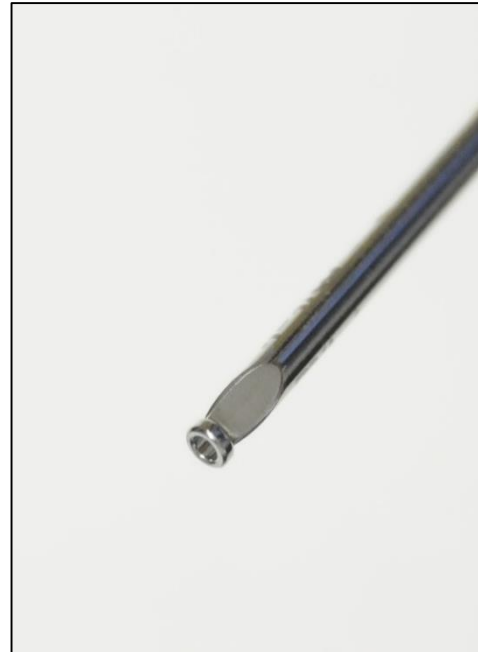

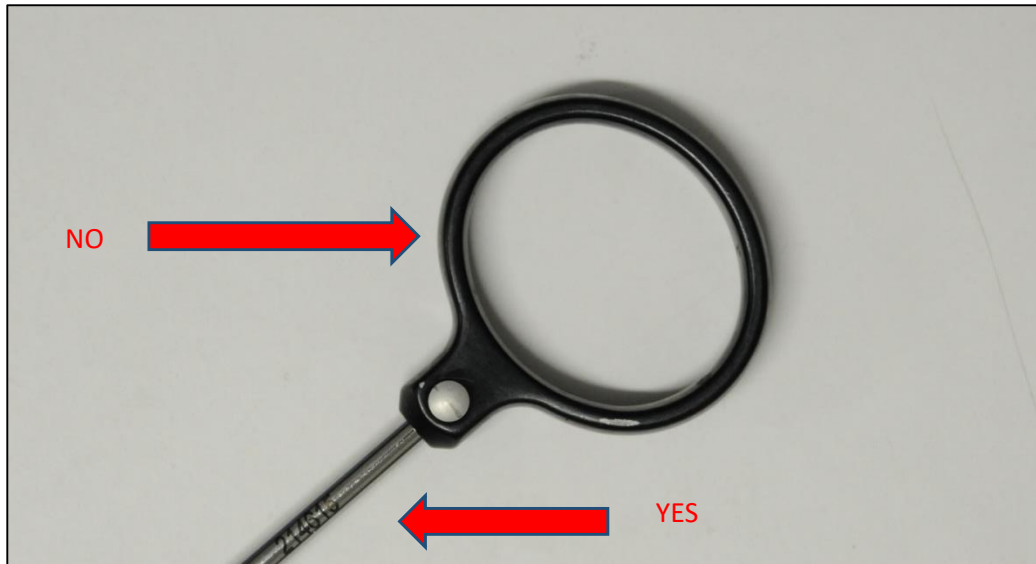

The coloured material (anodized aluminium) can be treated but with caution: keep a distance of at least 10/15 cm and make contact for a very short time (1/2 seconds).

10.16 ARTHROSCOPY FORCEPS - MITEK 214602

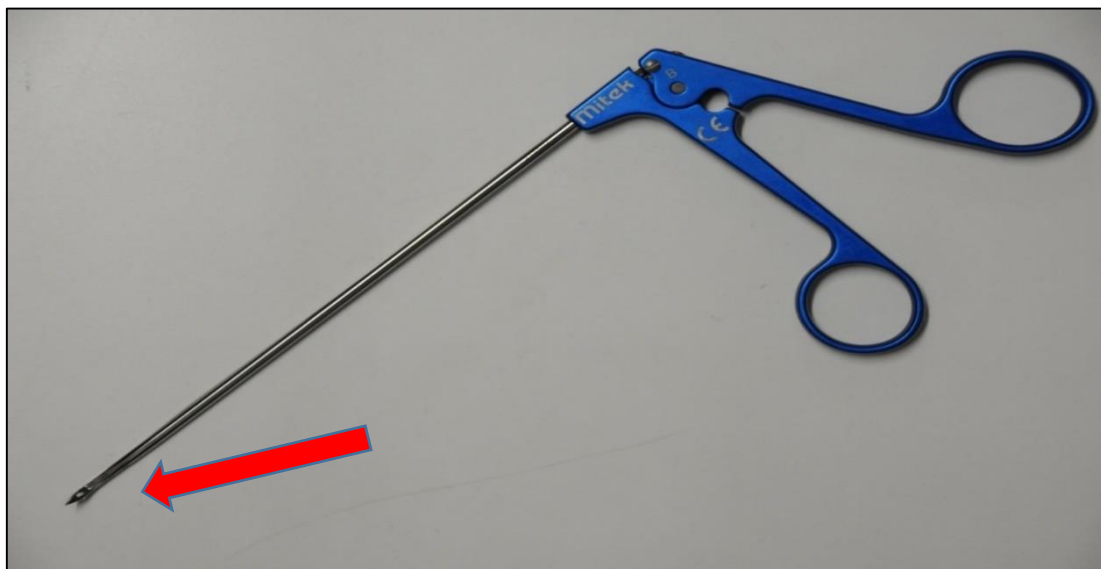

Carefully clean the ends



The coloured material (anodized aluminium) can be treated but with caution: keep a distance of at least 10/15 cm and make contact for a very short time (1/2 seconds).

10.17 KARL STORZ TROCAR 30 160 H2 (CANNULA WITH STOPCOCK)



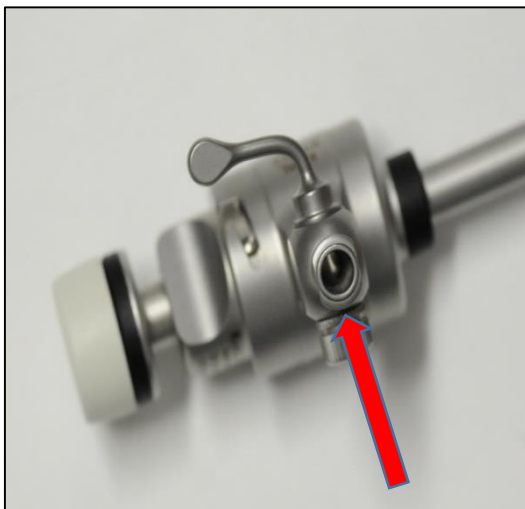
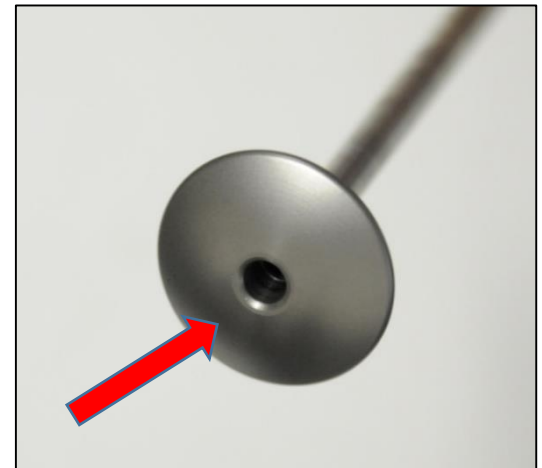
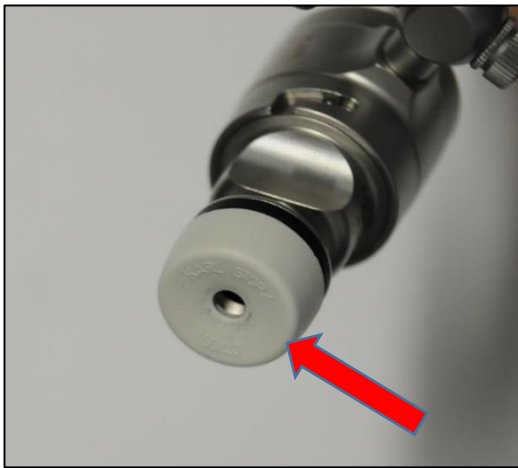
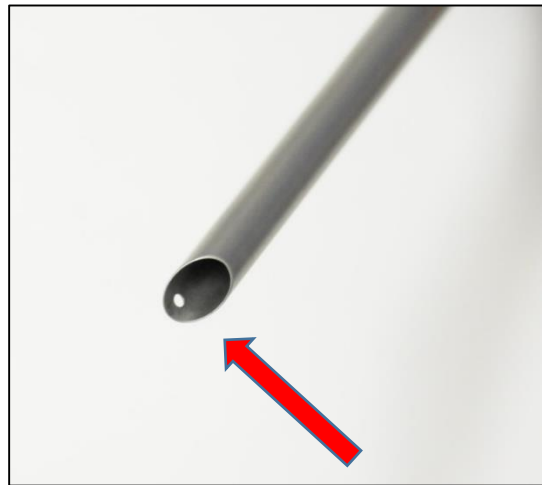

Carefully clean the ends and, where possible, attempt flushing (for cleaning the cannulated instruments refer to the procedure described in tutorial 4). Be careful not to treat the plastic parts.

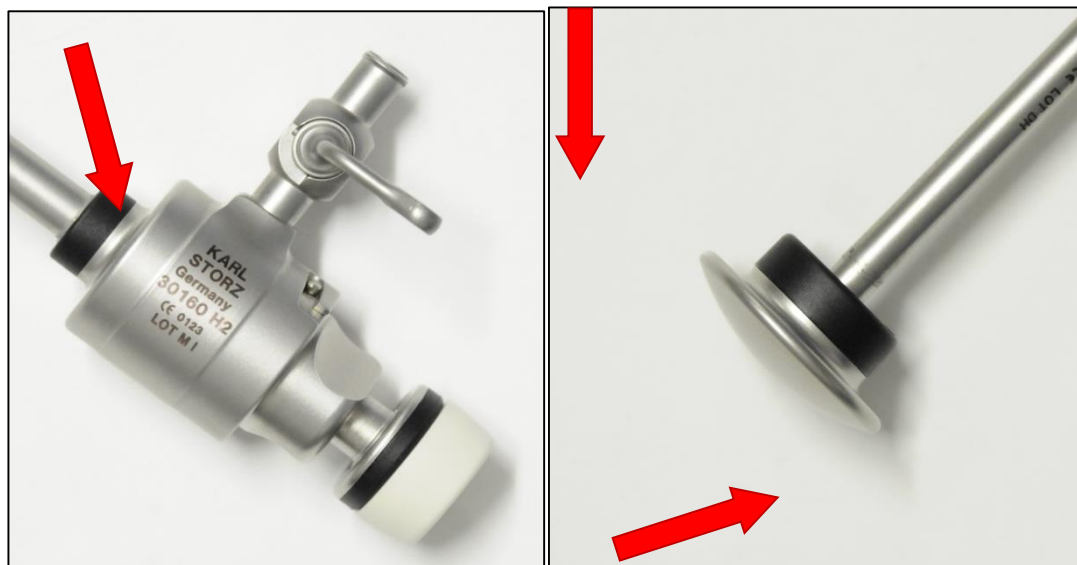

Do not treat the coloured plastic parts with the jet.

10.18 EYE MICROSURGERY KIT - STEEL

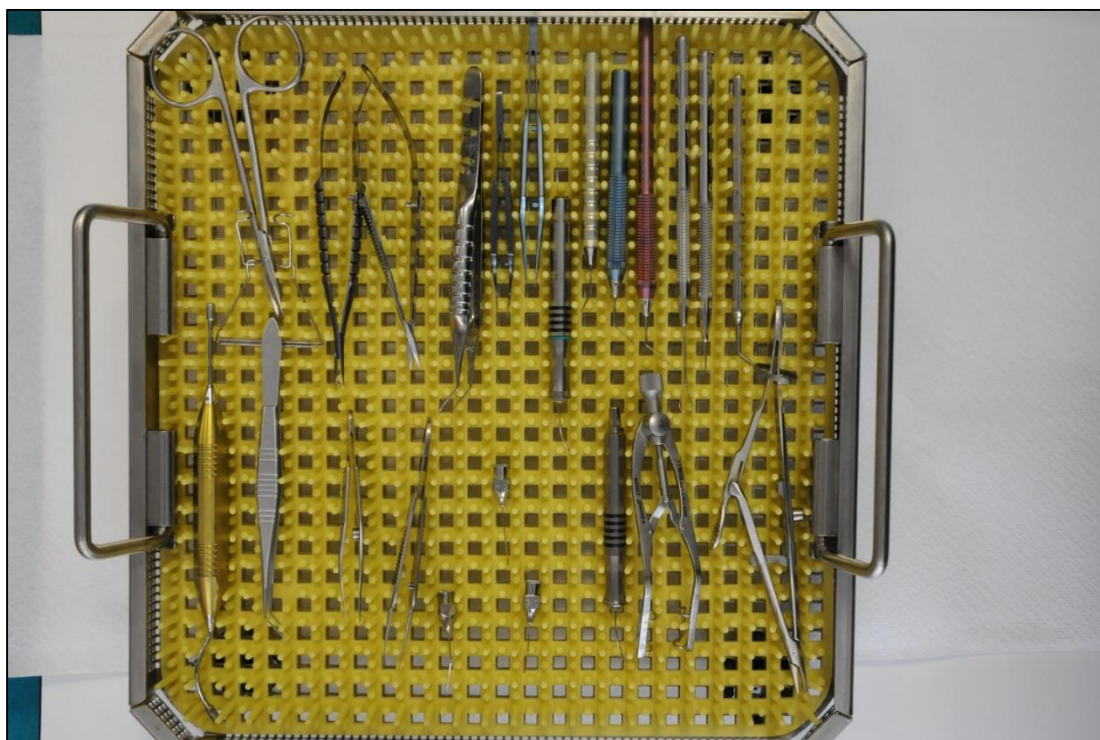

PROCEDURE: the kit is treated with bicarbonate directly in its container. After a first passage of about 60 seconds, the instruments are turned and retreated.

N.B.: (ON THE THINNER NEEDLES) follow the procedure in tutorial 4 for cannulated instruments.

After cleaning with bicarbonate, rinse thoroughly to remove any visible residue.

10.19 KARL STORZ ROD-LENS SYSTEM 27005AA

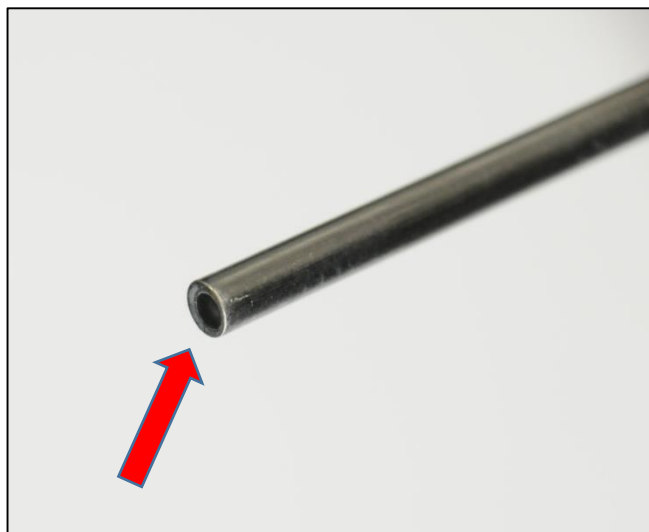

Procedure for cleaning the lens: Treat the area indicated by the arrow Very close distance, 2-5 cm Time: 60 seconds.

11 SW MANUAL - HMI PANEL

11.1 MACHINE READY - HOME SCREEN

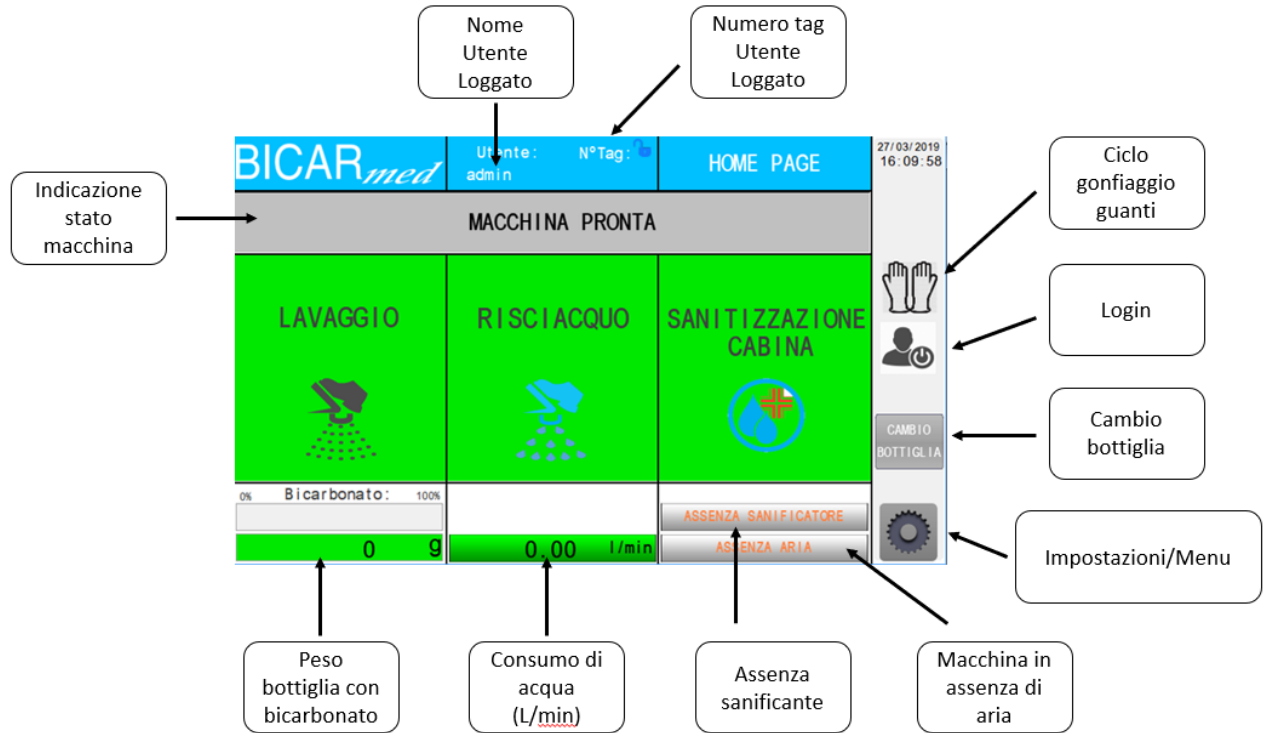

11.2 SETTINGS/MENU SCREEN

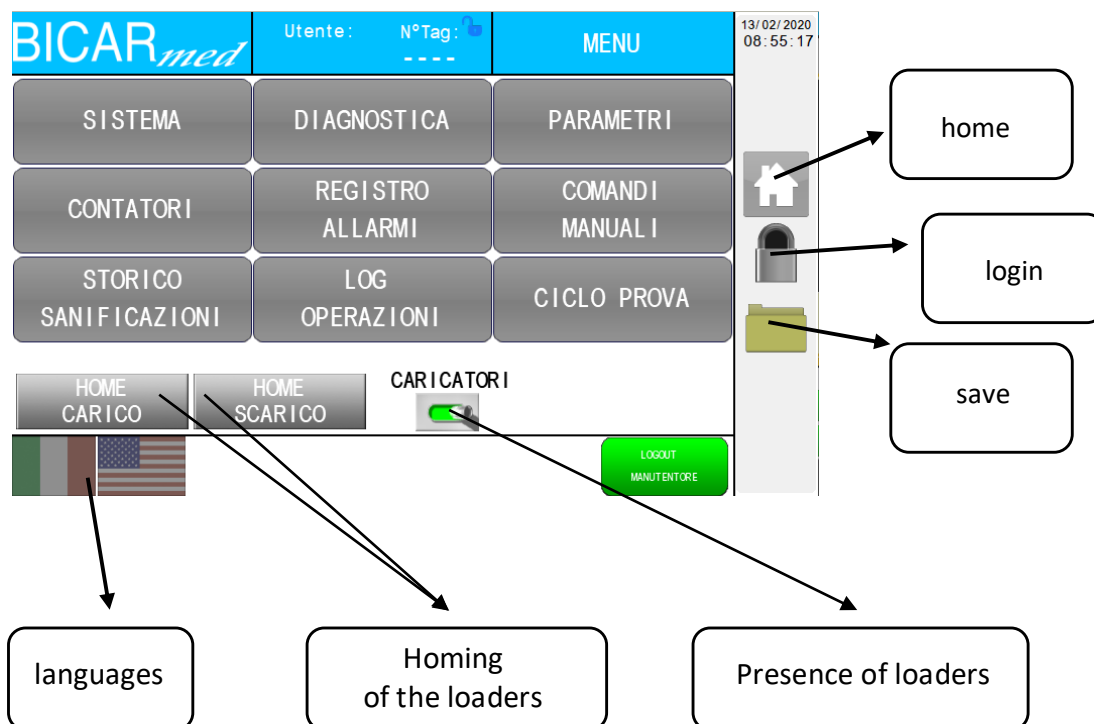

11.3 SISTEMA (SYSTEM) SCREEN

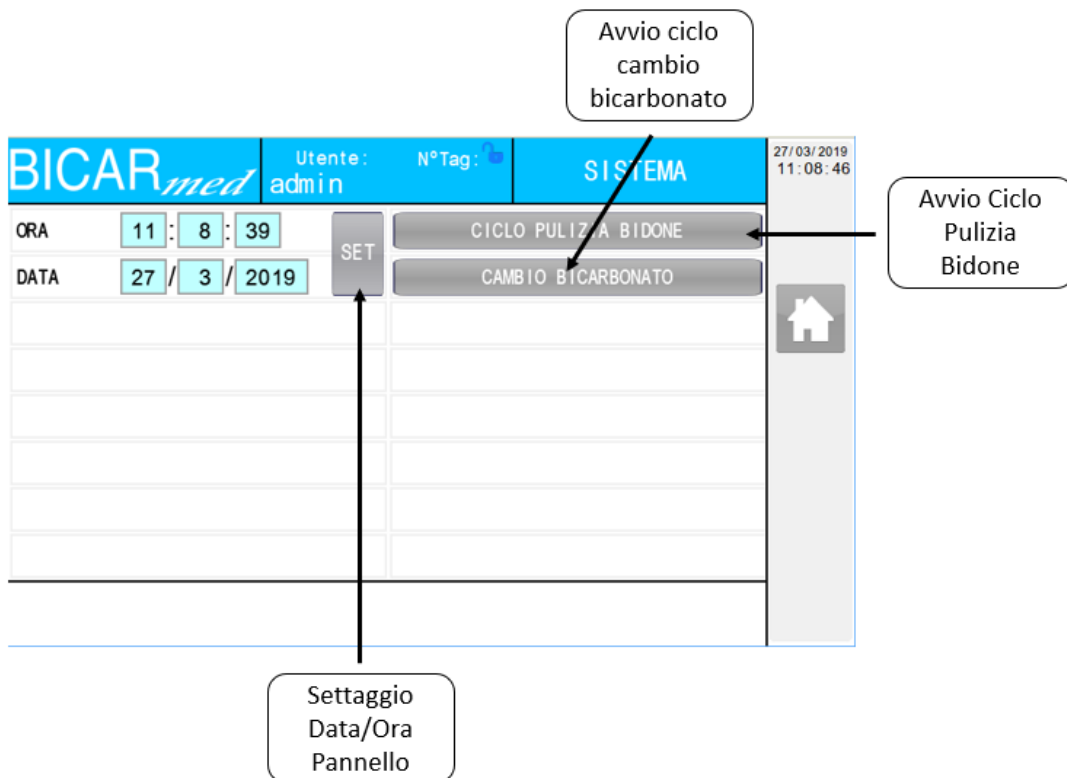

11.4 DIAGNOSTICA (DIAGNOSTICS) SCREENS

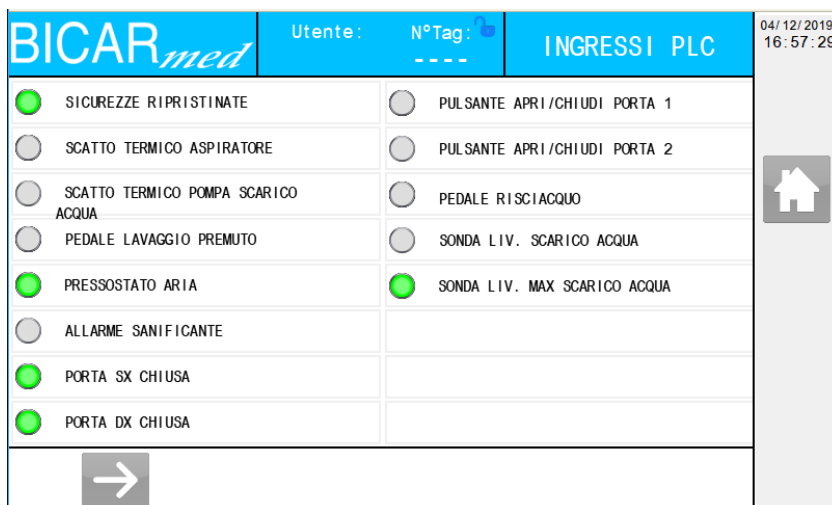

BICAR ^{med}		Utente:	N°Tag:	INGRESSI PLC	04/12/2019 16:59:27
<input type="radio"/>	PULSANTE AVVIO SANIFICAZIONE	<input type="radio"/>	SCARICO: FT VASSOIO PORTA		
<input checked="" type="radio"/>	CARICO: FT 1° POSIZIONE	<input type="radio"/>	PULSANTE RICHIESTA INGR. VASSOIO		
<input checked="" type="radio"/>	CARICO: FT 5° POSIZIONE	<input type="radio"/>	PULSANTE CARICO VASSOIO		
<input checked="" type="radio"/>	EMERGENZA CARICATORE	<input type="radio"/>	PULSANTE SCARICO VASSOIO		
<input type="radio"/>	CARICO: FT VASSOIO INGOMBRO PORTA	<input checked="" type="radio"/>	PULSANTE RESET ALLARMI		
<input checked="" type="radio"/>	SCARICO: FT 1° POSIZIONE	<input type="radio"/>	PORTA SX APERTA		
<input checked="" type="radio"/>	SCARICO: FT 5° POSIZIONE	<input type="radio"/>	PORTA DX APERTA		
<input checked="" type="radio"/>	EMERGENZA SCARICATORE				
<input type="button" value="←"/> <input type="button" value="→"/>					

BICAR ^{med}		Utente:	N°Tag:	INGRESSI PLC	04/12/2019 17:00:40
<input type="radio"/>	PULSANTE STAND-BY				
<input checked="" type="radio"/>	SENSORE HOME CARICATORE				
<input checked="" type="radio"/>	SENSORE HOME SCARICATORE				
<input checked="" type="radio"/>	EMERGENZA SU PANNELLO COMANDI				
<input checked="" type="radio"/>	EMERGENZA CABINA				
<input checked="" type="radio"/>	EMERGENZA BORDI PORTA CARICO				
<input checked="" type="radio"/>	EMERGENZA BORDI PORTA SCARICO				
<input type="button" value="←"/> <input type="button" value="→"/>					

BICAR ^{med}		Utente: admin	N°Tag:	USCITE PLC	27/03/2019 11:10:49
<input type="radio"/>	EV ACQUA GENERALE	<input type="radio"/>	SPIA BLU RISCIAQUO		
<input type="radio"/>	SPIA VERDE LAVAGGIO	<input type="radio"/>	SPIA PULSANTE SANIFICAZIONE		
<input type="radio"/>	SPIA ROSSA ALLARME	<input type="radio"/>	EV SCARICO ACQUA APRI		
<input type="radio"/>	CICALINA	<input type="radio"/>	EV SCARICO ACQUA CHIUDI		
<input type="radio"/>	PISTONE CHIUDI PORTE	<input type="radio"/>	EV ACQUA TERGICRISTALLO		
<input type="radio"/>	PISTONE APRI PORTE	<input type="radio"/>	EV RISCIAQUO BIDONE		
<input type="radio"/>	TERGICRISTALLO	<input type="radio"/>	EV ARIA UGELLO LAVAGGIO		
<input type="radio"/>	LUCE CABINA	<input type="radio"/>	EV ACQUA UGELLO LAVAGGIO		
<input type="button" value="←"/> <input type="button" value="→"/>					



11.5 PARAMETRI (PARAMETERS) SCREEN

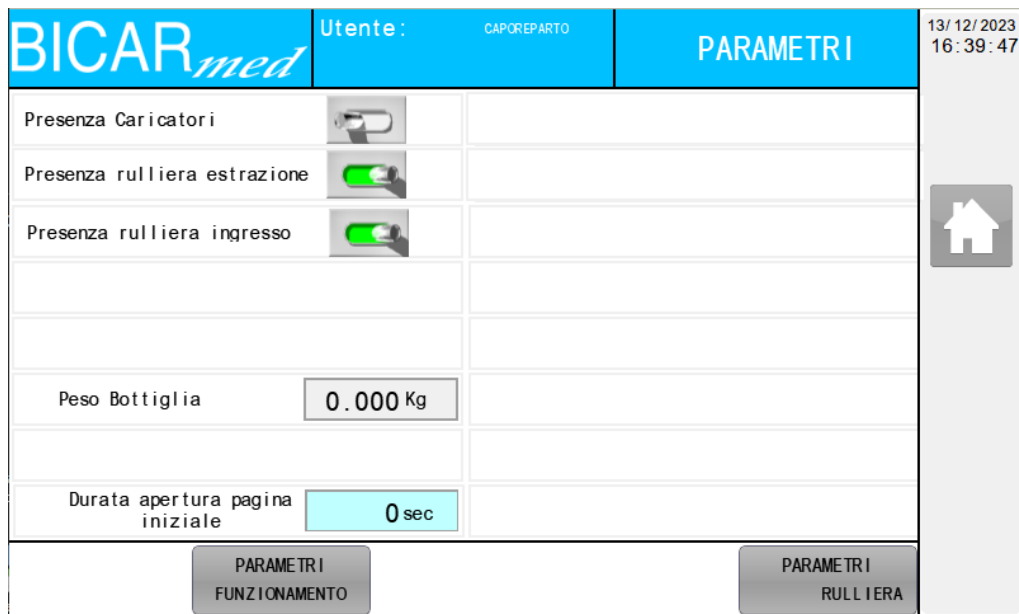

11.6 PARAMETRI DI FUNZIONAMENTO (OPERATING PARAMETERS) SETTING SCREENS

BICAR ^{med}		Utente:	N° Tag:	PARAMETRI FUNZIONAMENTO		01/04/2019 10:30:51			
Ritardo arresto svuotamento acqua	<input type="text" value="0.0 s"/>	Tempo pausa dosatrice sanificatore	<input type="text" value="0.0 s"/>						
Ritardo apertura trasporto ugello	<input type="text" value="0.0 s"/>	Tempo funzionamento dosatrice sanificatore	<input type="text" value="0.0 s"/>						
Ritardo apertura acqua ugello	<input type="text" value="0.0 s"/>	SANIFICAZIONE Tempo 1° Risciacquo	<input type="text" value="0.00 Min"/>						
Ritardo chiusura trasporto ugello	<input type="text" value="0.0 s"/>	SANIFICAZIONE Tempo Acqua + Sanificante	<input type="text" value="0.00 Min"/>						
Livello basso bicarbonato	<input type="text" value="0.000 kg"/>	SANIFICAZIONE Tempo Contatto	<input type="text" value="0.00 Min"/>						
Livello insufficiente bicarbonato	<input type="text" value="0.000 kg"/>	SANIFICAZIONE Tempo 2° Risciacquo	<input type="text" value="0.00 Min"/>						
Massimo aumento di peso	<input type="text" value="0.000 kg"/>	Tempo intervento allarme Sanificante	<input type="text" value="0.00 s"/>						
Tempo prima Stand-By	<input type="text" value="0 min"/>								

BICAR ^{med}		Utente:	N° Tag:	PARAMETRI FUNZIONAMENTO		13/02/2020 08:54:30			
Tempo transito vassoio caricatore	<input type="text" value="0.00 s"/>	Consumo Medio impostato per controllo	<input type="text" value="0 g/min"/>						
Tempo prima allarme mancanza acqua in lavaggio/risciacquo	<input type="text" value="0.00 s"/>	Tolleranza consumo medio per controllo	<input type="text" value="0 g/min"/>						
Tempo prima allarme mancanza acqua in sanificazione	<input type="text" value="0.00 s"/>	Flusso minimo acqua in lavaggio/risciacquo	<input type="text" value="0.00 l/min"/>						
Tempo attesa accensione tergicristallo	<input type="text" value="0.0 s"/>	Flusso minimo acqua in sanificazione	<input type="text" value="0.00 l/min"/>						
Tempo spegnimento acqua tergicristallo	<input type="text" value="0.0 s"/>								
Tempo funzionamento percolatori carico	<input type="text" value="0.0 s"/>								
Tempo funzionamento percolatori scarico	<input type="text" value="0.0 s"/>								
Tempo ciclo gonfiaggio guanti	<input type="text" value="0.0 s"/>								

11.7 CICLO PROVA (TEST CYCLE) SCREENS

BICAR _{med}		Utente:	N°Tag:	CICLO PROVA	13/02/2020 09:08:42
ASPIRATORE		SANIFICANTE			
ARIA RISCIAQUO		AUTOADDESCAMENTO SANIFICANTE			
ACQUA RISCIAQUO					
PERCOLATORI					
ARIA PROIEZIONE					
ACQUA PROIEZIONE		Tempo Ciclo Prova		50.0 s	
SCARICO ACQUA		AVVIO CICLO			
INIEZIONE ACQUA BIDONE					
Tempo passato	0.0 s	Tempo rimanente		50.0 s	

BICAR _{med}		Utente:	N°Tag:	CICLO PROVA	13/02/2020 09:07:53
ASPIRATORE		SANIFICANTE			
ARIA RISCIAQUO		AUTOADDESCAMENTO SANIFICANTE			
ACQUA RISCIAQUO					
PERCOLATORI					
ARIA PROIEZIONE					
ACQUA PROIEZIONE		Tempo Ciclo Prova		50.0 s	
SCARICO ACQUA					
INIEZIONE ACQUA BIDONE					
Tempo passato	0.0 s	Tempo rimanente		50.0 s	

11.8 CONTATORI (COUNTERS) SCREEN

BICAR ^{med}		Utente: admin	N° Tag:	CONTATORI	27/03/2019 11:13:43
Q.tà bottiglie bicarbonato	<input type="text" value="0"/>	Ore Tot Funzion Dosatrice	<input type="text" value="0"/>		
Numero cicli lavaggio	<input type="text" value="0"/>				
Numero cicli risciacquo	<input type="text" value="0"/>				
Numero cicli sanificazione	<input type="text" value="0"/>				
Ore lavoro macchina	<input type="text" value="0"/>				
Ore Tot Funzion Aspiratore	<input type="text" value="0"/>				
Ore Tot Funzion Pompa Scarico	<input type="text" value="0"/>				
Ore Tot Funzion Lavaggio	<input type="text" value="0"/>				

11.9 REGISTRO ALLARMI (ALARMS REGISTER) SCREEN

BICAR ^{med}		Utente: admin	N° Tag:	STORICO ALLARMI	27/03/2019 11:28:00
2019/03/27 10:36:18	0	00-			
2019/03/27 10:36:19	3	03-TERMICO POMPA ACQUA SCARICO			
2019/03/27 10:36:20	5	05-ACQUA INSUFFICIENTE			
2019/03/27 10:36:23	9	09-LIVELLO BICARBONATO INCOERENTE			
2019/03/27 10:55:24	1	01-EMERGENZA INSERITA			
2019/03/27 10:55:24	3	03-TERMICO POMPA ACQUA SCARICO			
2019/03/27 10:55:25	2	02-PORTE APERTE			
2019/03/27 10:55:33	41	41-ERRORE BUS DI COM. CON AZZ. SCARIC.			

File Filter

11.10 SANIFICAZIONI (SANITIZATION) LOG SCREEN



11.11 OPERAZIONI (OPERATION) LOG SCREEN

	Date / Time	Screen No.	User ID	Security Level	
1	2019/03/27 10:55	110	admin	15	Switch Action
2	2019/03/27 10:55		admin	15	ScrnChg
3	2019/03/27 10:55	70	admin	15	Switch Action
4	2019/03/27 10:55		admin	15	ScrnChg
5	2019/03/27 11:06	5	admin	15	Switch Action
6	2019/03/27 11:06		admin	15	ScrnChg
7	2019/03/27 11:06		admin	15	LangChg
8	2019/03/27 11:06	70	admin	15	Switch Action
9	2019/03/27 11:06	70	admin	15	Switch Action
10	2019/03/27 11:06		admin	15	ScrnChg
11	2019/03/27 11:08	5	admin	15	Switch Action
12	2019/03/27 11:08		admin	15	ScrnChg

1/4 [Default] [Set] [Close]

11.12 ESPORTAZIONE DATI (DATA EXPORT) MENU SCREEN



11.13 PORTE APERTE CABINA (CABIN OPEN DOORS) SCREEN

BICAR ^{med}		Utente: admin	N°Tag:	HOME PAGE	27/03/2019 11:45:26
PORTE APERTE CABINA					
LAVAGGIO 	RISCIACQUO 	SANITIZZAZIONE CABINA 		 CAMBIO BOTTIGLIA 	
0% Bicarbonato: 100%					
0	9	0.00	l/min		

11.14 MACCHINA IN STAND-BY (MACHINE IN STAND-BY) SCREEN

BICAR ^{med}		Utente: admin	N°Tag:	HOME PAGE	27/03/2019 11:46:11
MACCHINA IN STAND-BY					
LAVAGGIO 	RISCIACQUO 	SANITIZZAZIONE CABINA 		 CAMBIO BOTTIGLIA 	
0% Bicarbonato: 100%					
0	9	0.00	l/min		

11.15 LAVAGGIO ATTIVO (ACTIVE WASHING) SCREEN

BICAR ^{med}		Utente: admin	N°Tag:	HOME PAGE	27/03/2019 11:47:53
CICLO LAVAGGIO					
ATTIVO LAVAGGIO 	RISCIACQUO 	SANITIZZAZIONE CABINA 		 CAMBIO BOTTIGLIA 	
0% Bicarbonato: 100%					
0	9	0.00	l/min		

11.16 RISCIAQUO ATTIVO (ACTIVE RINSING) SCREEN

BICAR_{med} Utente: admin N°Tag: HOME PAGE 27/03/2019 11:49:50

CICLO RISCIAQUO

LAVAGGIO **ATTIVO** RISCIAQUO SANITIZZAZIONE CABINA

0% Bicarbonato: 100% 0 g 0.00 l/min ASSENZA SANIFICATORE ASSENZA ARIA

CAMBIO BOTTIGLIA

11.17 CICLO DI SANIFICAZIONE (SANITIZATION CYCLE) SCREEN

BICAR_{med} Utente: admin N°Tag: HOME PAGE 27/03/2019 11:52:21

CICLO SANIFICA

LAVAGGIO RISCIAQUO **ATTIVO** SANITIZZAZIONE CABINA

0% Bicarbonato: 100% 0 g 0.00 l/min ASSENZA ARIA

CAMBIO BOTTIGLIA

BICAR_{med} Utente: admin N°Tag: HOME PAGE 19/09/2019 16:24:29

SANIFICAZIONE
 ATTENZIONE CICLO SANIFICAZIONE SELEZIONATO
 CONTROLLARE CHE LA CABINA SIA VUOTA
 VUOI PROCEDERE CON LA SANIFICAZIONE?

RESET SANIFICAZIONE

PREMERE SANIFICAZIONE PER PROSEGUIRE
 PREMERE RESET PER ANNULLARE

0% Bicarbonato: 100% 0 g 0.00 l/min ASSENZA SANIFICATORE ASSENZA ARIA

Sanitization cycle selected; press the sanificazione (sanitization) button to start or press the reset button to cancel.

11.17.1 FIRST PHASE: RINSING THE CABIN WITH WATER ONLY



11.17.2 SECOND PHASE: RINSING OF THE CABIN WITH WATER AND SANITIZER



11.17.3 WAITING TIME BEFORE FINAL RINSE WITH WATER



11.17.4 THIRD PHASE: FINAL RINSE WITH WATER ONLY



11.18 REMINDER TO CARRY OUT SANITIZATION



Sanitization must be carried out: if it is not, it is saved in the SANITIZATION LOG.

11.19 CICLO GONFIAGGIO GUANTI (GLOVE INFLATION CYCLE) SCREEN



11.20 MACCHINA IN EMERGENZA (MACHINE IN EMERGENCY MODE) SCREEN

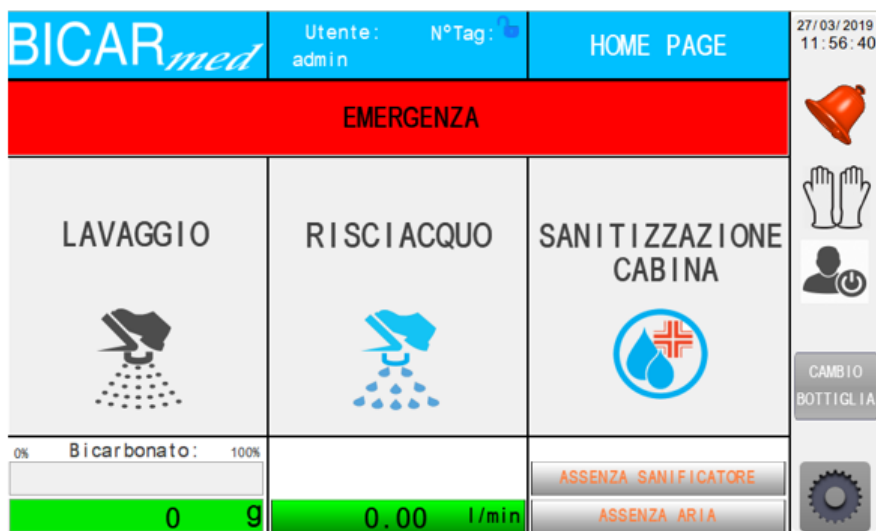

Allarme, premere la campanella per visualizzare gli allarmi inseriti